

GUTTERCREST

ALUMINIUM

**ASPIRE
GUTTERS**

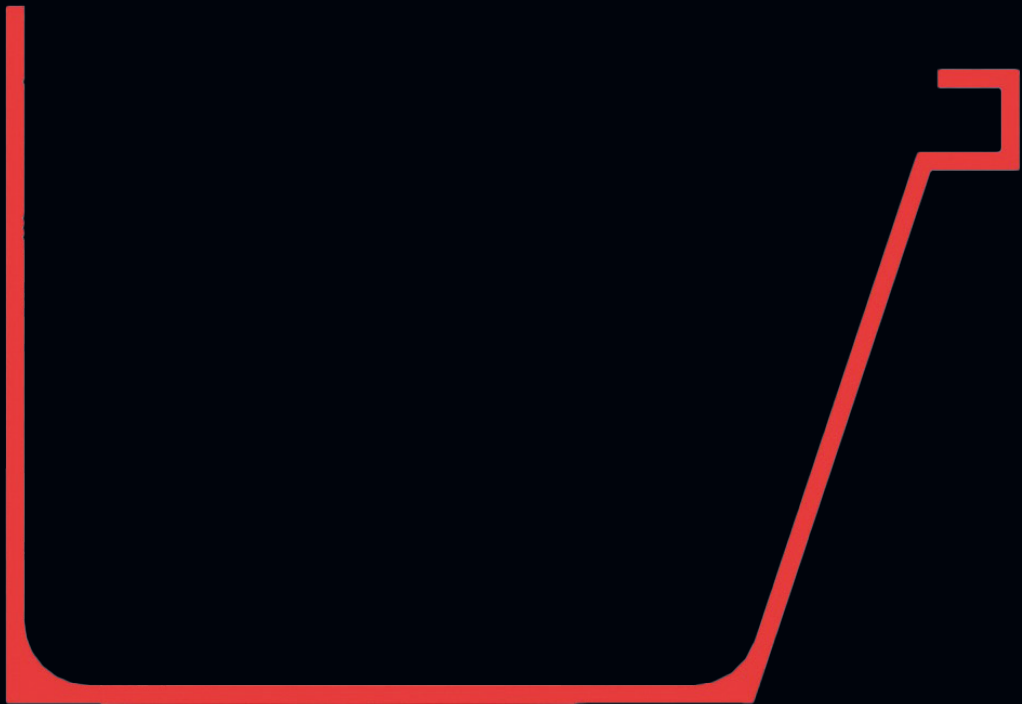

PRICE LIST

PRICE LIST

ASPIRE CONTEMPORARY OGEE GUTTER SYSTEM

STANDARD GUTTER LENGTHS

Gutter (mm)	125 x 75	160 x 100
3.0mtr	ASP1/1	ASP3/1
MILL	61.96	92.51
PPC	70.18	103.36
1.8mtr	ASP1/2	ASP3/2
MILL	43.76	54.12
PPC	48.70	60.64

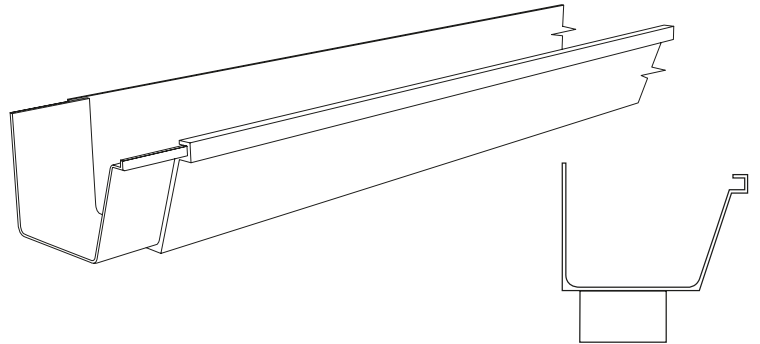

ANGLES - INTERNAL & EXTERNAL

Gutter (mm)	125 x 75	160 x 100
90° External	ASP1/3	ASP3/3
MILL	38.42	46.14
PPC	39.22	47.20
90° Internal	ASP1/4	ASP3/4
MILL	38.42	46.14
PPC	39.22	47.20
135° External	ASP1/5	ASP3/5
MILL	37.48	44.62
PPC	38.12	45.47
135° Internal	ASP1/6	ASP3/6
MILL	37.48	44.62
PPC	38.12	45.47
Irregular External	ASP1/7	ASP3/7
MILL	48.99	57.79
PPC	49.82	58.89
Irregular Internal	ASP1/8	ASP3/8
MILL	48.99	57.79
PPC	49.82	58.89

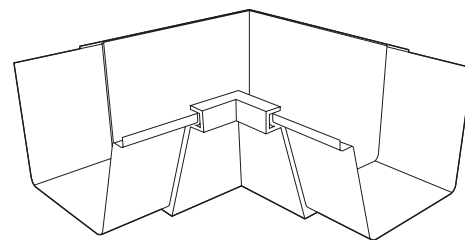

Internal Angle

STOP ENDS

Gutter (mm)	125 x 75	160 x 100
Stop End Right Hand	ASP1/10	ASP3/10
MILL	11.11	11.75
PPC	11.66	12.30
Stop End Left Hand	ASP1/11	ASP3/11
MILL	11.11	11.75
PPC	11.66	12.30

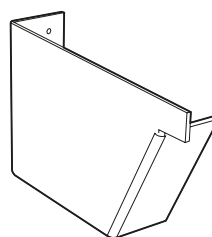

Left Hand

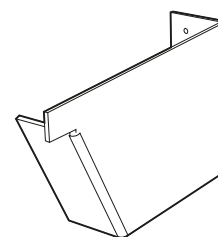

Right Hand

NOTE: THESE ARE INTERNAL STOP ENDS

PRICE LIST

ASPIRE CONTEMPORARY OGEE GUTTER SYSTEM

SLEEVE OUTLETS - ROUND

Gutter (mm)	125 x 75	160 x 100
63mm Ø	ASP1/SO13	ASP3/SO13
MILL	-	-
PPC	-	-
75mm Ø	ASP1/SO14	ASP3/SO14
MILL	-	-
PPC	-	-
100mm Ø	ASP1/SO15	ASP3/SO15
MILL	-	-
PPC	-	-

Please Note

Sleeve Outlets can be used in place of Running Outlets giving increased flexibility and cost efficiency.

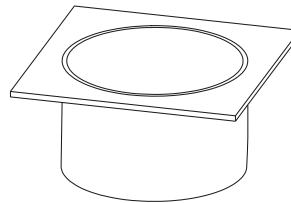

SLEEVE OUTLETS - SQUARE & RECTANGULAR

Gutter (mm)	125 x 75	160 x 100
75 x 50mm	ASP1/SO18	ASP3/SO18
MILL	-	-
PPC	-	-
75 x 75mm	ASP1/SO19	ASP3/SO19
MILL	-	-
PPC	-	-
100 x 75mm	ASP1/SO20	ASP3/SO20
MILL	-	-
PPC	-	-
100 x 100mm	ASP1/SO21	ASP3/SO21
MILL	-	-
PPC	-	-

Please Note

Sleeve Outlets can be used in place of Running Outlets giving increased flexibility and cost efficiency.

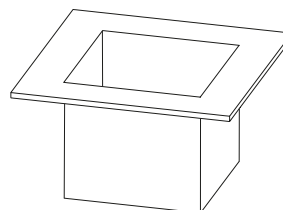

PRICE LIST

ASPIRE CONTEMPORARY OGEE GUTTER SYSTEM

RUNNING OUTLETS - ROUND

Gutter (mm)	125 x 75	160 x 100
63mm Ø	ASP1/13	ASP3/13
MILL	40.17	45.55
PPC	40.86	46.47
75mm Ø	ASP1/14	ASP3/14
MILL	43.59	46.59
PPC	44.28	47.51
100mm Ø	ASP1/15	ASP3/15
MILL	-	51.00
PPC	-	51.92

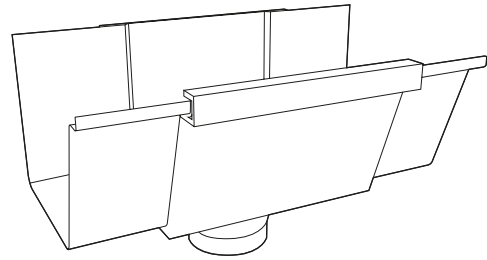

Please Note

Sleeve Outlets can be used in place of Running Outlets giving increased flexibility and cost efficiency.

RUNNING OUTLETS - SQUARE & RECTANGULAR

Gutter (mm)	125 x 75	160 x 100
75 x 50mm	ASP1/18	ASP3/18
MILL	39.90	49.95
PPC	40.59	50.87
75 x 75mm	ASP1/19	ASP3/19
MILL	45.29	51.28
PPC	45.98	52.20
100 x 75mm	ASP1/20	ASP3/20
MILL	46.96	50.05
PPC	47.65	50.97
100 x 100mm	ASP1/21	ASP3/21
MILL	-	53.59
PPC	-	54.51

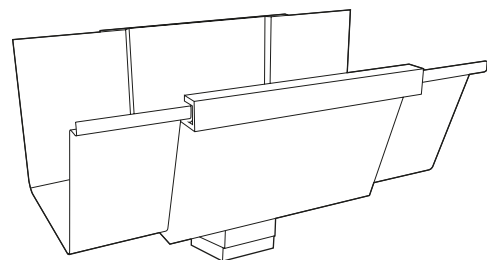

Please Note

Sleeve Outlets can be used in place of Running Outlets giving increased flexibility and cost efficiency.

PRICE LIST

ASPIRE CONTEMPORARY OGEE GUTTER SYSTEM

STOPEND OUTLETS RIGHT HAND & LEFT HAND - ROUND

Gutter (mm)	Right Hand Stop End Outlets		Left Hand Stop End Outlets	
	125 x 75	160 x 100	100 x 75	150 x 100
63mm Ø	ASP1/130	ASP3/130	ASP1/131	ASP3/131
MILL	39.06	44.36	39.06	44.36
PPC	39.75	45.28	39.75	45.28
75mm Ø	ASP1/140	ASP3/140	ASP1/141	ASP3/141
MILL	42.49	45.41	42.49	45.41
PPC	43.18	46.33	43.18	46.33
100mm Ø	ASP1/150	ASP3/150	ASP1/151	ASP3/151
MILL	-	49.82	-	49.82
PPC	-	50.74	-	50.74

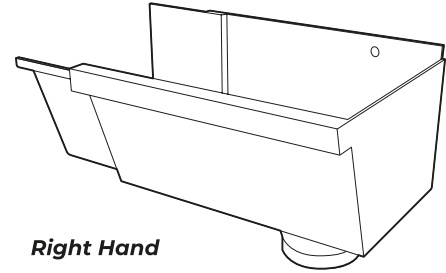

Right Hand

Please Note
Sleeve Outlets can be used in place of Running Outlets giving increased flexibility and cost efficiency.

STOPEND OUTLETS RIGHT HAND & LEFT HAND - SQUARE & RECTANGULAR

Gutter (mm)	Right Hand Stop End Outlets		Left Hand Stop End Outlets	
	125 x 75	160 x 100	100 x 75	150 x 100
75 x 50mm	ASP1/180	ASP3/180	ASP1/181	ASP3/181
MILL	38.80	48.77	38.80	48.77
PPC	39.49	49.69	39.49	49.69
75 x 75mm	ASP1/190	ASP3/190	ASP1/191	ASP3/191
MILL	44.20	51.28	44.20	51.28
PPC	44.89	52.20	44.89	52.20
100 x 75mm	ASP1/200	ASP3/200	ASP1/201	ASP3/201
MILL	45.87	48.87	45.87	48.87
PPC	46.56	49.79	46.56	49.79
100 x 100mm	ASP1/210	ASP3/210	ASP1/211	ASP3/211
MILL	-	52.42	-	52.42
PPC	-	53.34	-	53.34

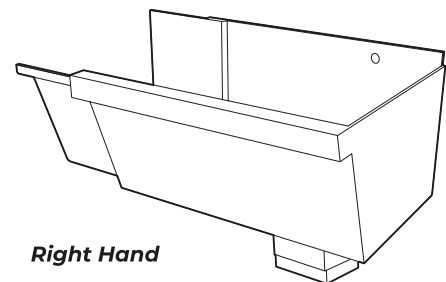

Right Hand

Please Note
Sleeve Outlets can be used in place of Running Outlets giving increased flexibility and cost efficiency.

PRICE LIST

ASPIRE CONTEMPORARY OGEE GUTTER SYSTEM

RAFTER & MORTAR BRACKETS

Gutter (mm)	125 x 75	160 x 100
Side Rafter	ASP1/29	ASP3/29
MILL	9.48	9.48
PPC	10.03	10.03
Top Rafter	ASP1/30	ASP3/30
MILL	8.23	8.23
PPC	8.78	8.78
Mortar	ASP1/31	ASP3/31
MILL	10.35	10.35
PPC	10.90	10.90

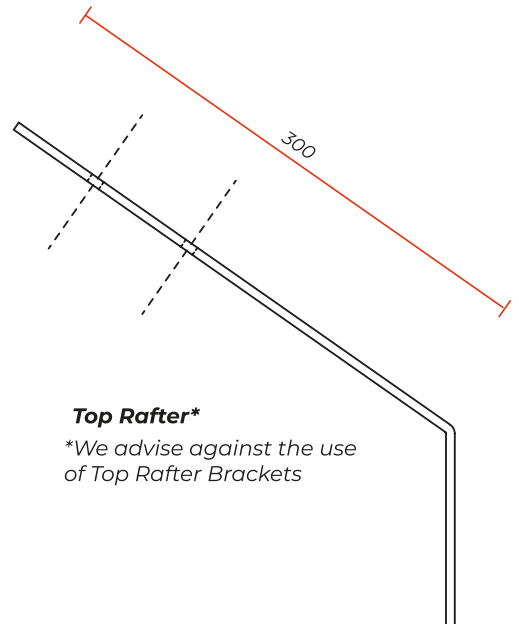
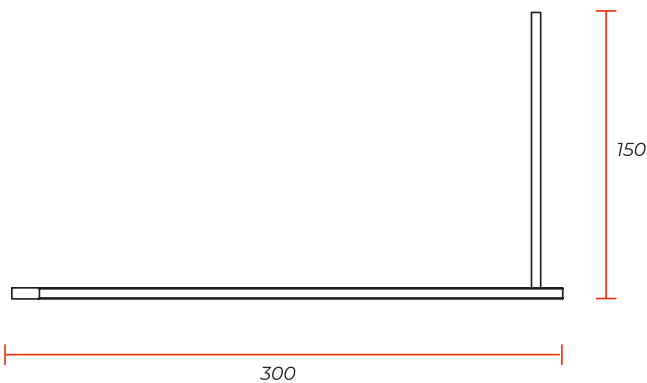
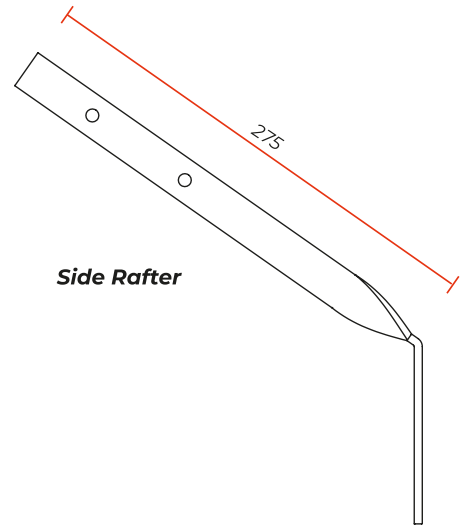

PRICE LIST

FIXINGS & SEALANTS

Code	Qty	Description	Price
GM1	25	Gutter Fixing 38 x 5.5 A2 Stainless Steel	4.56
GM2	100	Gutter Fixing 38 x 5.5 A2 Stainless Steel	13.86
GM3	200	Gutter Fixing 38 x 5.5 A2 Stainless Steel	26.90



GM1 - GM5

Code	Qty	Description	Price
GM201	25	4.8 x 14.7 All Aluminium sealed Rivet	3.38
GM202	100	4.8 x 14.7 All Aluminium sealed Rivet	12.46
GM203	200	4.8 x 14.7 All Aluminium sealed Rivet	23.38



GM201 - GM203

Code	Qty	Description	Price
GM610	25	6.3mm STRUCTURAL Aluminium Rivet	10.97
GM620	100	6.3mm STRUCTURAL Aluminium Rivet	39.11
GM630	200	6.3mm STRUCTURAL Aluminium Rivet	78.21



GM610 - GM620

Code	Qty	Description	Price
GM20	25	Downpipe Fixing 6 x 50 A2 Stainless Steel	9.81
GM21	100	Downpipe Fixing 6 x 50 A2 Stainless Steel	32.84



GM20 - GM21

Code	Qty	Description	Price
GM30	1	380ml Cartridge Silicone Sealant - Grey	11.00
GM32	1	1no 12mtr Reel Butyl Tape 12mm x 3mm	6.56
GM40	1	Touch Up Paint - Colour to match order	23.98
GM50	1	1no Drill Bit 4.8mm	2.06
GM51	1	1no Drill Bit 6.4mm	2.74



GM30



GM32



GM50 - GM60

Code	Qty	Description	Price
GM910	1	Standard Rainwater Rivet Gun	20.13
GM920	1	Professional Rivet Gun - Interchangeable collets for rain-water and structural rivets	115.19



GM910



GM920

PRICE LIST

CARRIAGE CHARGES

GUTTERS, DOWNPIPES & HOPPERS

TOTAL NET ORDER VALUE (EXCLUDING VAT)		PRICE
£0 - £99	BOXED UP TO 10KG	£15 Min Charge
£0 - £99	3M LENGTHS UP TO 10KGS	£30
£100 - £624		£40
£625 - £1249		£55
£1250 PLUS		FREE DELIVERY

Delivery Exclusions Apply:
Please see the Charges
section below

COPING, FASCIAS & SOFFITS

TOTAL NET ORDER VALUE (EXCLUDING VAT)	PRICE
£0 - £150	£40
£151 - £1249	£95
£1250 PLUS	FREE DELIVERY

Delivery Exclusions Apply:
Please see the Charges
section below

CHARGES

With a fleet of Guttercrest vehicles and outside couriers, we deliver all our aluminium products to your local builders merchant or direct to site.

SCOTTISH MAINLAND

Standard carriage charges apply on
Postcode areas: DG, EH, G, KA, KY, TD

ALSO TO INCLUDE: DD1 - DD7, FK1 - FK7, FK9 - FK15,
FK8 STERLING ONLY (Rest of FK8 will be price on application),
KY1 - KY16, PA1 - PA19, PH1 - PH4, PH12 - PH14

All other Scottish Mainland, carriage price on application.

NON MAINLAND

For delivery to Northern Ireland, The Republic of Ireland
and all offshore Islands, carriage Price on application.

EXPORT

Price on application.

Tel: +44 (0)1691 663300

Email: info@guttercrest.co.uk

VAT will be charged at the appropriate rate.

