

GUTTERCREST

ALUMINIUM

BOX GUTTERS

LARGE SIZES

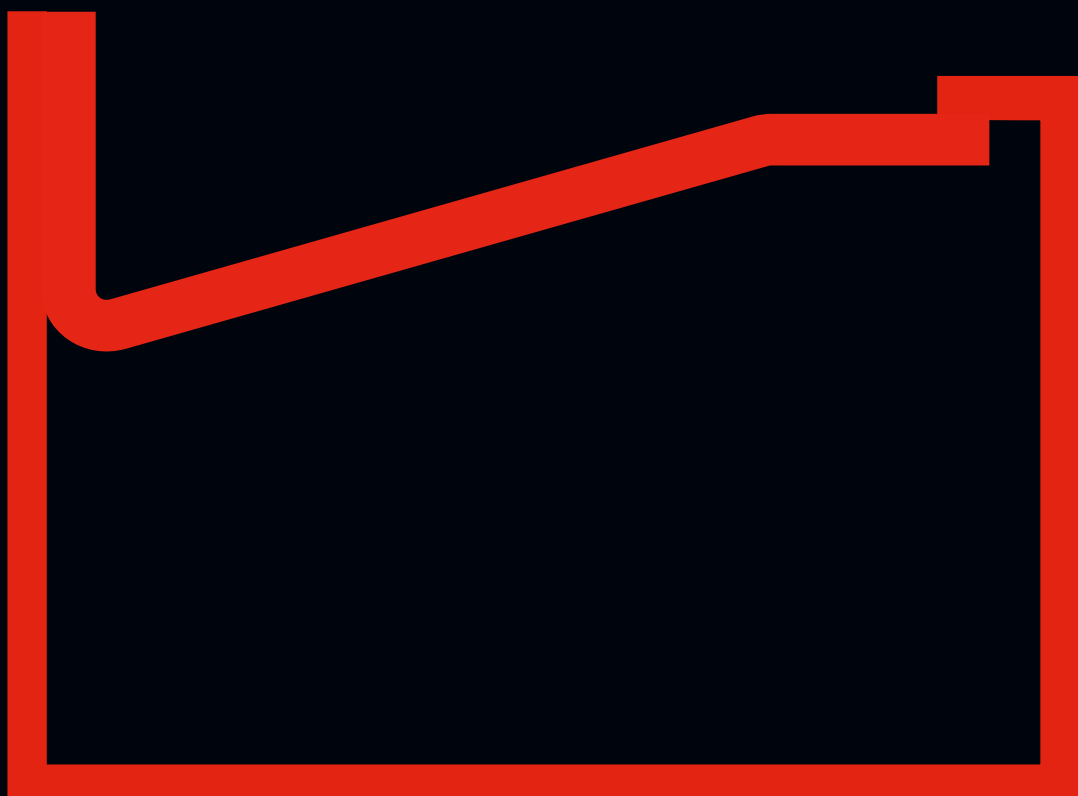

PRICE LIST

PRICE LIST

BOX GUTTER SYSTEM - LARGE SIZES

STANDARD GUTTER LENGTHS

Gutter (mm)	150 x 150	200 x 150	200 x 200	300 x 200
3.0mtr	BX5/1	BX6/1	BX7/1	BX8/1
MILL	110.96	134.75	146.02	191.20
PPC	126.32	151.80	166.32	215.18
1.5mtr	BX5/2	BX6/2	BX7/2	BX8/2
MILL	70.98	85.25	96.78	123.21
PPC	78.66	93.78	106.94	135.21

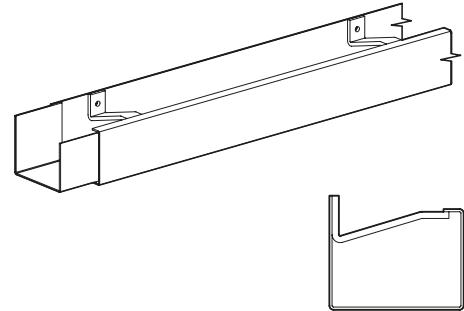

ANGLES INTERNAL & EXTERNAL

Gutter (mm)	150 x 150	200 x 150	200 x 200	300 x 200
90° External	BX5/3	BX6/3	BX7/3	BX8/3
MILL	69.23	83.56	95.33	116.13
PPC	72.41	87.38	99.87	121.90
90° Internal	BX5/4	BX6/4	BX7/4	BX8/4
MILL	69.23	83.56	95.33	116.13
PPC	72.41	87.38	99.87	121.90
135° External	BX5/5	BX6/5	BX7/5	BX8/5
MILL	66.38	83.11	91.52	111.57
PPC	69.20	86.25	95.25	116.38
135° Internal	BX5/6	BX6/6	BX7/6	BX8/6
MILL	66.38	83.11	91.52	111.57
PPC	69.20	86.25	95.25	116.38
Irregular External	BX5/7	BX6/7	BX7/7	BX8/7
MILL	103.79	125.38	129.70	151.63
PPC	107.89	129.94	135.12	158.32
Irregular Internal	BX5/8	BX6/8	BX7/8	BX8/8
MILL	103.79	125.38	129.70	151.63
PPC	107.89	129.94	135.12	158.32

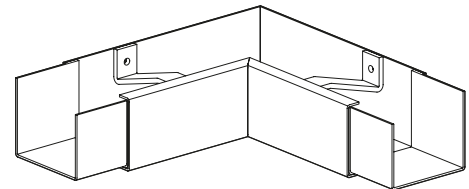

Internal Angle

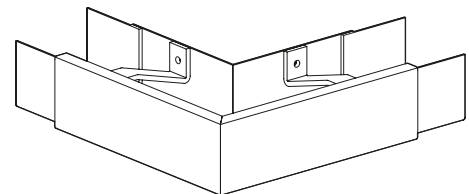

External Angle

STOP ENDS

Gutter (mm)	150 x 150	200 x 150	200 x 200	300 x 200
Stop End Right Hand	BX5/10	BX6/10	BX7/10	BX8/10
MILL	9.93	11.89	12.52	14.51
PPC	10.48	12.44	13.13	15.35
Stop End Left Hand	BX5/11	BX6/11	BX7/11	BX8/11
MILL	9.93	11.89	12.52	14.51
PPC	10.48	12.44	13.13	15.35

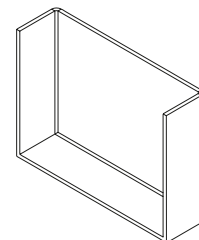

Right Hand Shown

NOTE: THESE ARE INTERNAL STOP ENDS

PRICE LIST

BOX GUTTER SYSTEM - LARGE SIZES

SLEEVE OUTLETS - ROUND

Gutter (mm)	150 x 150	200 x 150	200 x 200	300 x 200
63mm Ø	BX5/SO13	BX6/SO13	BX7/SO13	BX8/SO13
MILL	10.91	10.91	10.91	10.91
PPC	11.46	11.46	11.46	11.46
75mm Ø	BX5/SO14	BX6/SO14	BX7/SO14	BX8/SO14
MILL	10.91	10.91	10.91	10.91
PPC	11.46	11.46	11.46	11.46
100mm Ø	BX5/SO15	BX6/SO15	BX7/SO15	BX8/SO15
MILL	12.69	12.69	12.69	12.69
PPC	13.24	13.24	13.24	13.24
125mm Ø	BX5/SO16	BX6/SO16	BX7/SO16	BX8/SO16
MILL	12.69	12.69	12.69	12.69
PPC	13.24	13.24	13.24	13.24
150mm Ø	BX5/SO17	BX6/SO17	BX7/SO17	BX8/SO17
MILL	-	14.40	14.40	14.40
PPC	-	14.95	14.95	14.95

Please Note

Sleeve Outlets can be used in place of Running Outlets giving increased flexibility and cost efficiency.

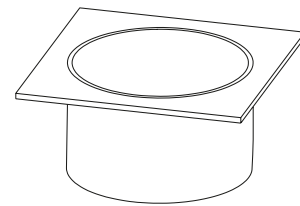

SLEEVE OUTLETS - SQUARE & RECTANGULAR

Gutter (mm)	150 x 150	200 x 150	200 x 200	300 x 200
75 x 50mm	BX5/SO18	BX6/SO18	BX7/SO18	BX8/SO18
MILL	10.91	10.91	10.91	10.91
PPC	11.46	11.46	11.46	11.46
75 x 75mm	BX5/SO19	BX6/SO19	BX7/SO19	BX8/SO19
MILL	10.91	10.91	10.91	10.91
PPC	11.46	11.46	11.46	11.46
100 x 75mm	BX5/SO20	BX6/SO20	BX7/SO20	BX8/SO20
MILL	10.91	10.91	10.91	10.91
PPC	11.46	11.46	11.46	11.46
100 x 100mm	BX5/SO21	BX6/SO21	BX7/SO21	BX8/SO21
MILL	12.69	12.69	12.69	12.69
PPC	13.24	13.24	13.24	13.24
100 x 100mm	BX5/SO22	BX6/SO22	BX7/SO22	BX8/SO22
MILL	14.40	14.40	14.40	14.40
PPC	14.95	14.95	14.95	14.95

Please Note

Sleeve Outlets can be used in place of Running Outlets giving increased flexibility and cost efficiency.

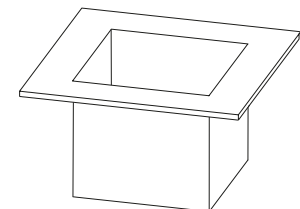

PRICE LIST

BOX GUTTER SYSTEM - LARGE SIZES

RUNNING OUTLETS - ROUND

Gutter (mm)	150 x 150	200 x 150	200 x 200	300 x 200
63mm Ø	BX5/13	BX6/13	BX7/13	BX8/13
MILL	60.91	72.62	80.52	94.97
PPC	62.81	74.73	83.04	97.94
75mm Ø	BX5/14	BX6/14	BX7/14	BX8/14
MILL	61.97	73.67	81.57	96.01
PPC	63.87	75.78	84.09	98.98
100mm Ø	BX5/15	BX6/15	BX7/15	BX8/15
MILL	64.95	76.66	84.55	99.00
PPC	66.85	78.77	87.07	101.97
125mm Ø	BX5/16	BX6/16	BX7/16	BX8/16
MILL	70.48	83.90	90.38	105.10
PPC	72.64	86.30	93.23	108.47
150mm Ø	BX5/17	BX6/17	BX7/17	BX8/17
MILL	-	86.24	92.73	107.44
PPC	-	88.64	95.58	110.81

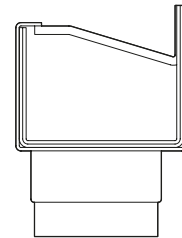
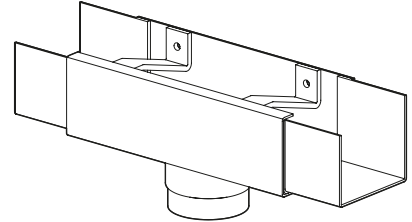

Please Note

Sleeve Outlets can be used in place of Running Outlets giving increased flexibility and cost efficiency.

RUNNING OUTLETS - SQUARE & RECTANGULAR

Gutter (mm)	150 x 150	200 x 150	200 x 200	300 x 200
75 x 50mm	BX5/18	BX6/18	BX7/18	BX8/18
MILL	65.32	77.03	84.92	99.37
PPC	67.22	79.14	87.44	102.34
75 x 75mm	BX5/19	BX6/19	BX7/19	BX8/19
MILL	66.65	78.36	86.25	100.70
PPC	68.55	80.47	88.77	103.67
100 x 75mm	BX5/20	BX6/20	BX7/20	BX8/20
MILL	66.36	78.07	85.96	100.41
PPC	68.26	80.18	88.48	103.38
100 x 100mm	BX5/21	BX6/21	BX7/21	BX8/21
MILL	70.49	82.19	90.10	104.54
PPC	72.39	84.30	92.62	107.51
150 x 100mm	BX5/22	BX6/22	BX7/22	BX8/22
MILL	71.11	83.58	90.07	105.73
PPC	73.27	85.98	92.92	109.10
150 x 150mm	BX5/23	BX6/23	BX7/23	BX8/23
MILL	-	87.42	93.91	109.57
PPC	-	89.82	96.76	112.94

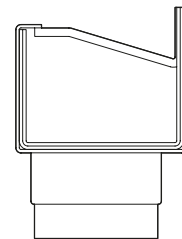
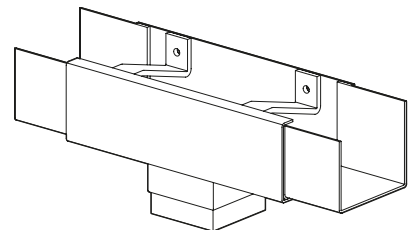

Please Note

Sleeve Outlets can be used in place of Running Outlets giving increased flexibility and cost efficiency.

PRICE LIST

FIXINGS & SEALANTS

Code	Qty	Description	Price
GM1	25	Gutter Fixing 38 x 5.5 A2 Stainless Steel	4.56
GM2	100	Gutter Fixing 38 x 5.5 A2 Stainless Steel	13.86
GM3	200	Gutter Fixing 38 x 5.5 A2 Stainless Steel	26.90



GM1 - GM5

Code	Qty	Description	Price
GM201	25	4.8 x 14.7 All Aluminium sealed Rivet	3.38
GM202	100	4.8 x 14.7 All Aluminium sealed Rivet	12.46
GM203	200	4.8 x 14.7 All Aluminium sealed Rivet	23.38



GM201 - GM203

Code	Qty	Description	Price
GM610	25	6.3mm STRUCTURAL Aluminium Rivet	10.97
GM620	100	6.3mm STRUCTURAL Aluminium Rivet	39.11
GM630	200	6.3mm STRUCTURAL Aluminium Rivet	78.21



GM610 - GM620

Code	Qty	Description	Price
GM20	25	Downpipe Fixing 6 x 50 A2 Stainless Steel	9.81
GM21	100	Downpipe Fixing 6 x 50 A2 Stainless Steel	32.84



GM20 - GM21

Code	Qty	Description	Price
GM30	1	380ml Cartridge Silicone Sealant - Grey	11.00
GM32	1	1no 12mtr Reel Butyl Tape 12mm x 3mm	6.56
GM40	1	Touch Up Paint - Colour to match order	23.98
GM50	1	1no Drill Bit 4.8mm	2.06
GM51	1	1no Drill Bit 6.4mm	2.74



GM30



GM32



GM50 - GM60

Code	Qty	Description	Price
GM910	1	Standard Rainwater Rivet Gun	20.13
GM920	1	Professional Rivet Gun - Interchangeable collets for rain-water and structural rivets	115.19



GM910



GM920

PRICE LIST

CARRIAGE CHARGES

GUTTERS, DOWNPIPES & HOPPERS

TOTAL NET ORDER VALUE (EXCLUDING VAT)		PRICE
£0 - £99	BOXED UP TO 10KG	£15 Min Charge
£0 - £99	3M LENGTHS UP TO 10KGS	£30
£100 - £624		£40
£625 - £1249		£55
£1250 PLUS		FREE DELIVERY

Delivery Exclusions Apply:
Please see the Charges
section below

COPING, FASCIAS & SOFFITS

TOTAL NET ORDER VALUE (EXCLUDING VAT)	PRICE
£0 - £150	£40
£151 - £1249	£95
£1250 PLUS	FREE DELIVERY

Delivery Exclusions Apply:
Please see the Charges
section below

CHARGES

With a fleet of Guttercrest vehicles and outside couriers, we deliver all our aluminium products to your local builders merchant or direct to site.

SCOTTISH MAINLAND

Standard carriage charges apply on
Postcode areas: DG, EH, G, KA, KY, TD

ALSO TO INCLUDE: DD1 - DD7, FK1 - FK7, FK9 - FK15,
FK8 STERLING ONLY (Rest of FK8 will be price on application),
KY1 - KY16, PA1 - PA19, PH1 - PH4, PH12 - PH14

All other Scottish Mainland, carriage price on application.

NON MAINLAND

For delivery to Northern Ireland, The Republic of Ireland
and all offshore Islands, carriage Price on application.

EXPORT

Price on application.

Tel: +44 (0)1691 663300

Email: info@guttercrest.co.uk

VAT will be charged at the appropriate rate.

