

# **GUTTERCREST**

**ALUMINIUM**

**MOULDED OGEE LARGE  
GUTTERS**

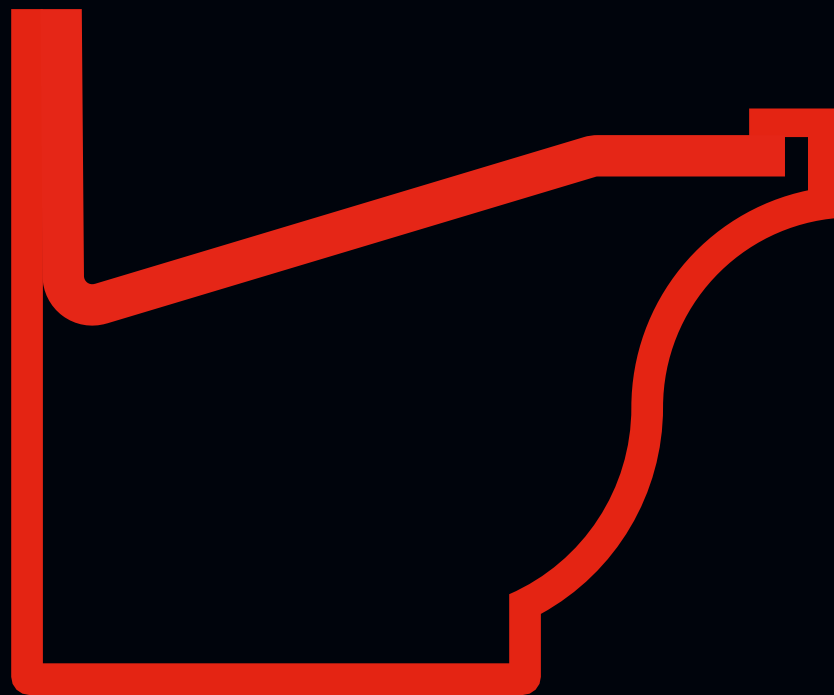

**PRICE LIST**

## PRICE LIST

### MOULDED OGEE GUTTER SYSTEM - LARGE SIZES

#### STANDARD GUTTER LENGTHS

Gutter (mm)	175 x 125	200 x 150	300 x 200
3.0mtr	MOG4/1	MOG5/1	MOG6/1
MILL	109.87	122.91	184.77
PPC	123.14	138.27	206.61
1.5mtr	MOG4/2	MOG5/2	MOG6/2
MILL	69.53	77.40	112.57
PPC	76.17	85.09	123.50

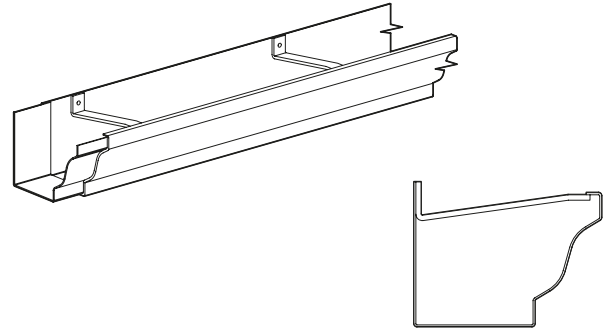

#### ANGLES - INTERNAL & EXTERNAL

Gutter (mm)	175 x 125	200 x 150	300 x 200
90° External	MOG4/3	MOG5/3	MOG6/3
MILL	72.59	81.90	127.46
PPC	75.23	85.08	132.71
90° Internal	MOG4/4	MOG5/4	MOG6/4
MILL	72.59	81.90	127.46
PPC	75.23	85.08	132.71
135° External	MOG4/5	MOG5/5	MOG6/5
MILL	72.26	81.51	126.63
PPC	74.40	84.09	130.60
135° Internal	MOG4/6	MOG5/6	MOG6/6
MILL	72.26	81.51	126.63
PPC	74.40	84.09	130.60
Irregular External	MOG4/7	MOG5/7	MOG6/7
MILL	76.00	85.79	133.96
PPC	78.42	88.84	139.69
Irregular Internal	MOG4/8	MOG5/8	MOG6/8
MILL	76.00	85.79	133.96
PPC	78.42	88.84	139.69

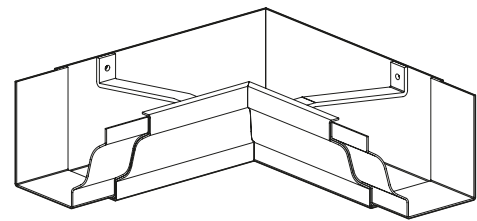

Internal Angle

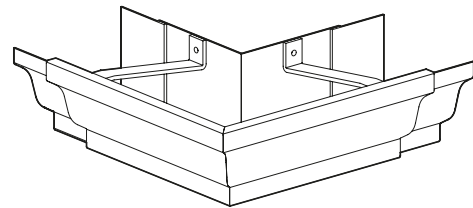

External Angle

#### STOP ENDS

Gutter (mm)	175 x 125	200 x 150	300 x 200
Stop End Right Hand	MOG4/10	MOG5/10	MOG6/10
MILL	16.99	19.49	25.47
PPC	17.54	20.04	26.17
Stop End Left Hand	MOG4/11	MOG5/11	MOG6/11
MILL	16.99	19.49	25.47
PPC	17.54	20.04	26.17

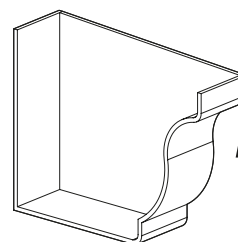

Right Hand shown

NOTE: THESE ARE INTERNAL STOP ENDS

## PRICE LIST

### MOULDED OGEE GUTTER SYSTEM - LARGE SIZES

#### RUNNING OUTLETS - ROUND

Gutter (mm)	175 x 125	200 x 150	300 x 200
63mm Ø	MOG4/13	MOG5/13	MOG6/13
MILL	63.88	76.03	98.09
PPC	64.99	77.32	99.92
75mm Ø	MOG4/14	MOG5/14	MOG6/14
MILL	64.91	77.07	99.13
PPC	66.02	78.36	100.96
100mm Ø	MOG4/15	MOG5/15	MOG6/15
MILL	67.88	80.04	102.10
PPC	68.99	81.33	103.93
125mm Ø	MOG4/16	MOG5/16	MOG6/16
MILL	72.14	84.47	104.49
PPC	73.48	86.02	106.69
150mm Ø	MOG4/17	MOG5/17	MOG6/17
MILL	74.46	86.79	109.32
PPC	75.80	88.34	111.52

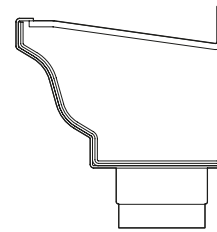
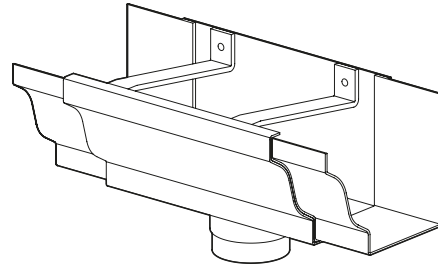

**Please Note**

Sleeve Outlets can be used in place of Running Outlets giving increased flexibility and cost efficiency.

#### RUNNING OUTLETS - SQUARE & RECTANGULAR

Gutter (mm)	175 x 125	200 x 150	300 x 200
75 x 50mm	MOG4/18	MOG5/18	MOG6/18
MILL	68.27	80.43	102.48
PPC	69.38	81.72	104.31
75 x 75mm	MOG4/19	MOG5/19	MOG6/19
MILL	69.59	81.76	103.80
PPC	70.70	83.05	105.63
100 x 75mm	MOG4/20	MOG5/20	MOG6/20
MILL	68.43	80.59	102.64
PPC	69.54	81.88	104.47
100 x 100mm	MOG4/21	MOG5/21	MOG6/21
MILL	72.45	84.61	106.67
PPC	73.56	85.90	108.50
150 x 100mm	MOG4/22	MOG5/22	MOG6/22
MILL	73.65	84.82	105.15
PPC	74.99	86.37	107.35
150 x 150mm	MOG4/23	MOG5/23	MOG6/23
MILL	78.92	89.45	108.02
PPC	80.26	91.00	110.22

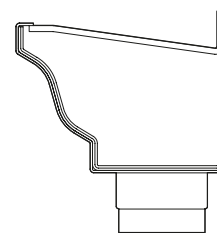
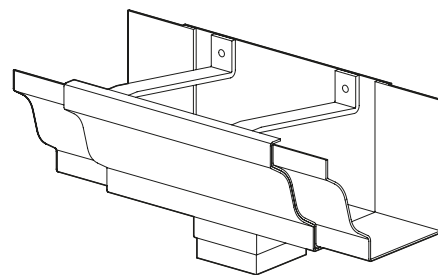

**Please Note**

Sleeve Outlets can be used in place of Running Outlets giving increased flexibility and cost efficiency.

## PRICE LIST

### MOULDED OGEE GUTTER SYSTEM - LARGE SIZES

#### SLEEVE OUTLETS - ROUND

Gutter (mm)	175 x 125	200 x 150	300 x 200
63mm Ø	MOG4/SO13	MOG5/SO13	MOG6/SO13
MILL	10.91	10.91	10.91
PPC	11.46	11.46	11.46
75mm Ø	MOG4/SO14	MOG5/SO14	MOG6/SO14
MILL	10.91	10.91	10.91
PPC	11.46	11.46	11.46
100mm Ø	MOG4/SO15	MOG5/SO15	MOG6/SO15
MILL	12.69	12.69	12.69
PPC	13.24	13.24	13.24
125mm Ø	MOG4/SO16	MOG5/SO16	MOG6/SO16
MILL	-	12.69	12.69
PPC	-	13.24	13.24
150mm Ø	MOG4/SO17	MOG5/SO17	MOG6/SO17
MILL	-	-	14.40
PPC	-	-	14.95

**Please Note**

Sleeve Outlets can be used in place of Running Outlets giving increased flexibility and cost efficiency.

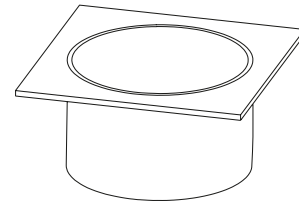

#### SLEEVE OUTLETS - SQUARE & RECTANGULAR

Gutter (mm)	175 x 125	200 x 150	300 x 200
75 x 50mm	MOG4/SO18	MOG5/SO18	MOG6/SO18
MILL	10.91	10.91	10.91
PPC	11.46	11.46	11.46
75 x 75mm	MOG4/SO19	MOG5/SO19	MOG6/SO19
MILL	10.91	10.91	10.91
PPC	11.46	11.46	11.46
100 x 75mm	MOG4/SO20	MOG5/SO20	MOG6/SO20
MILL	10.91	10.91	10.91
PPC	11.46	11.46	11.46
100 x 100mm	MOG4/SO21	MOG5/SO21	MOG6/SO21
MILL	12.69	12.69	12.69
PPC	13.24	13.24	13.24

**Please Note**

Sleeve Outlets can be used in place of Running Outlets giving increased flexibility and cost efficiency.

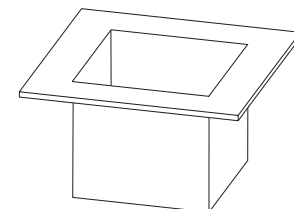

## PRICE LIST

### FIXINGS & SEALANTS

Code	Qty	Description	Price
GM1	25	Gutter Fixing 38 x 5.5 A2 Stainless Steel	4.56
GM2	100	Gutter Fixing 38 x 5.5 A2 Stainless Steel	13.86
GM3	200	Gutter Fixing 38 x 5.5 A2 Stainless Steel	26.90



GM1 - GM5

Code	Qty	Description	Price
GM201	25	4.8 x 14.7 All Aluminium sealed Rivet	3.38
GM202	100	4.8 x 14.7 All Aluminium sealed Rivet	12.46
GM203	200	4.8 x 14.7 All Aluminium sealed Rivet	23.38



GM201 - GM203

Code	Qty	Description	Price
GM610	25	6.3mm STRUCTURAL Aluminium Rivet	10.97
GM620	100	6.3mm STRUCTURAL Aluminium Rivet	39.11
GM630	200	6.3mm STRUCTURAL Aluminium Rivet	78.21



GM610 - GM620

Code	Qty	Description	Price
GM20	25	Downpipe Fixing 6 x 50 A2 Stainless Steel	9.81
GM21	100	Downpipe Fixing 6 x 50 A2 Stainless Steel	32.84



GM20 - GM21

Code	Qty	Description	Price
GM30	1	380ml Cartridge Silicone Sealant - Grey	11.00
GM32	1	1no 12mtr Reel Butyl Tape 12mm x 3mm	6.56
GM40	1	Touch Up Paint - Colour to match order	23.98
GM50	1	1no Drill Bit 4.8mm	2.06
GM51	1	1no Drill Bit 6.4mm	2.74



GM30



GM32



GM50 - GM60

Code	Qty	Description	Price
GM910	1	Standard Rainwater Rivet Gun	20.13
GM920	1	Professional Rivet Gun - Interchangeable collets for rain-water and structural rivets	115.19



GM910



GM920

# PRICE LIST

## CARRIAGE CHARGES

### GUTTERS, DOWNPIPES & HOPPERS

TOTAL NET ORDER VALUE (EXCLUDING VAT)		PRICE
£0 - £99	BOXED UP TO 10KG	£15 Min Charge
£0 - £99	3M LENGTHS UP TO 10KGS	£30
£100 - £624		£40
£625 - £1249		£55
£1250 PLUS		FREE DELIVERY

Delivery Exclusions Apply:  
Please see the Charges  
section below

### COPING, FASCIAS & SOFFITS

TOTAL NET ORDER VALUE (EXCLUDING VAT)	PRICE
£0 - £150	£40
£151 - £1249	£95
£1250 PLUS	FREE DELIVERY

Delivery Exclusions Apply:  
Please see the Charges  
section below

### CHARGES

With a fleet of Guttercrest vehicles and outside couriers, we deliver all our aluminium products to your local builders merchant or direct to site.

#### SCOTTISH MAINLAND

Standard carriage charges apply on  
Postcode areas: DG, EH, G, KA, KY, TD

ALSO TO INCLUDE: DD1 - DD7, FK1 - FK7, FK9 - FK15,  
FK8 STERLING ONLY (Rest of FK8 will be price on application),  
KY1 - KY16, PA1 - PA19, PH1 - PH4, PH12 - PH14

All other Scottish Mainland, carriage price on application.

#### NON MAINLAND

For delivery to Northern Ireland, The Republic of Ireland  
and all offshore Islands, carriage Price on application.

#### EXPORT

Price on application.

Tel: +44 (0)1691 663300

Email: [info@guttercrest.co.uk](mailto:info@guttercrest.co.uk)

VAT will be charged at the appropriate rate.

