

# GUTTERCREST

## ALUMINIUM

### SQUARE & RECTANGLE DOWNPIPES



75 X 75 mm  
3 X 3"



75 X 50 mm  
3 X 2"



100 X 100 mm  
4 X 4"

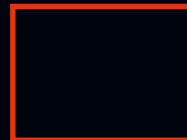

100 X 75 mm  
4 X 3"



150 X 150 mm  
6 X 6"

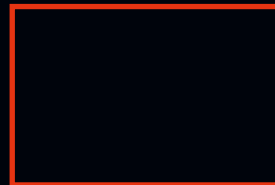

150 X 100 mm  
6 X 4"

## PRICE LIST

## PRICE LIST

### SQUARE & RECTANGULAR DOWNPIPE SYSTEM

#### DOWNPIPE LENGTHS

Pipe (mm)	75 x 50	75 x 75	100 x 75	100 x 100	150 x 100	150 x 150
3.0mtr	RW32/1	RW33/1	RW43/1	RW44/1	RW64/1	RW66/1
MILL	40.94	49.59	67.58	77.30	119.71	160.34
PPC	49.20	59.50	79.14	90.52	135.97	179.85
1.5mtr	RW32/4	RW33/4	RW43/4	RW44/4	RW64/4	RW66/4
MILL	25.86	31.16	41.17	46.85	72.89	94.81
PPC	29.99	36.12	46.95	53.46	81.02	104.57



#### ACCESS PIPES & PLATES

Pipe (mm)	75 x 50	75 x 75	100 x 75	100 x 100	150 x 100	150 x 150
Pipe With Plate	RW32/8	RW33/8	RW43/8	RW44/8	RW64/8	RW66/8
MILL	28.84	32.50	39.31	43.02	62.17	69.14
PPC	31.04	35.14	42.43	46.59	66.67	74.54
Plate Only	RW32/9	RW33/9	RW43/9	RW44/9	RW64/9	RW66/9
MILL	4.27	4.27	5.10	5.10	6.89	6.89
PPC	4.82	4.82	5.65	5.65	7.44	7.44

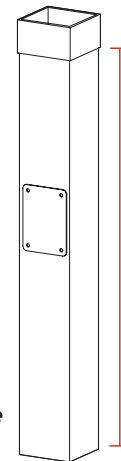

Approx 700mm

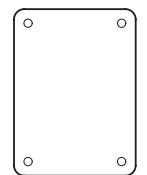

Access Plate

Access Pipe With Plate

#### SHOES

Pipe (mm)	75 x 50	75 x 75	100 x 75	100 x 100	150 x 100	150 x 150
Shoe	RW32/10	RW33/10	RW43/10	RW44/10	RW64/10	RW66/10
MILL	27.75	22.44	36.42	41.77	62.42	79.15
PPC	28.30	23.11	37.20	42.76	63.74	81.04

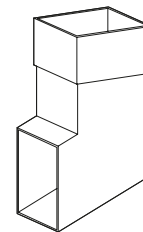

112.5°

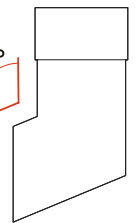

#### UNIVERSAL BRANCHES

Pipe (mm)	75 x 50	75 x 75	100 x 75	100 x 100	150 x 100	150 x 150
Branch	RW32/11	RW33/11	RW43/11	RW44/11	RW64/11	RW66/11
MILL	44.32	43.42	59.40	62.83	101.83	116.86
PPC	45.81	44.64	60.94	64.59	104.47	120.03

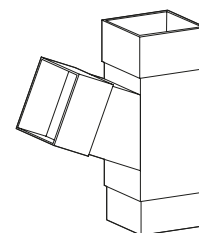

112.5° or 92.5°

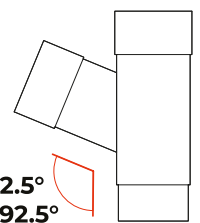

NOTE: NORMALLY USED WITH A BEND

112.5° branch shown

## PRICE LIST

### SQUARE & RECTANGULAR DOWNPIPE SYSTEM

#### PIPE CLIPS & BRACKETS

Pipe (mm)	75 x 50	75 x 75	100 x 75	100 x 100	150 x 100	150 x 150
Standard Pipe Clip	RW32/16	RW33/16	RW43/16	RW44/16	RW64/16	RW66/16
MILL	3.81	3.81	3.89	3.89	6.71	6.71
PPC	4.36	4.36	4.44	4.44	7.26	7.26

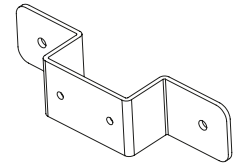

Standard Pipe Clip

Pipe (mm)	75 x 50	75 x 75	100 x 75	100 x 100	150 x 100	150 x 150
Tee Bkt 100mm	RW32/17	RW33/17	RW43/17	RW44/17	RW64/17	RW66/17
MILL	10.45	10.45	10.63	10.63	11.52	11.52
PPC	11.00	11.00	11.18	11.18	12.07	12.07
Tee Bkt 200mm	RW32/18	RW33/18	RW43/18	RW44/18	RW64/18	RW66/18
MILL	11.29	11.29	11.45	11.45	12.34	12.34
PPC	11.84	11.84	12.00	12.00	12.89	12.89
Tee Bkt 300mm	RW32/19	RW33/19	RW43/19	RW44/19	RW64/19	RW66/19
MILL	12.21	12.21	12.37	12.37	13.26	13.26
PPC	12.76	12.76	12.92	12.92	13.81	13.81

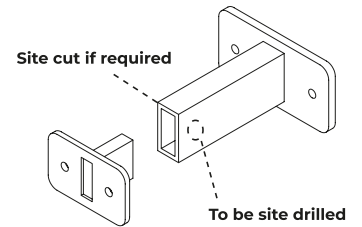

Tee Bracket

Pipe (mm)	75 x 50	75 x 75	100 x 75	100 x 100	150 x 100	150 x 150
Mullion Bkt 100mm	RW32/171	RW33/171	RW43/171	RW44/171	RW64/171	RW66/171
MILL	10.45	10.45	10.63	10.63	10.91	10.91
PPC	11.00	11.00	11.18	11.18	11.46	11.46
Mullion Bkt 200mm	RW32/181	RW33/181	RW43/181	RW44/181	RW64/181	RW66/181
MILL	11.29	11.29	11.45	11.45	12.34	12.34
PPC	11.84	11.84	12.00	12.00	12.89	12.89
Mullion Bkt 300mm	RW32/191	RW33/191	RW43/191	RW44/191	RW64/191	RW66/191
MILL	12.21	12.21	12.37	12.37	13.26	13.26
PPC	12.76	12.76	12.92	12.92	13.81	13.81

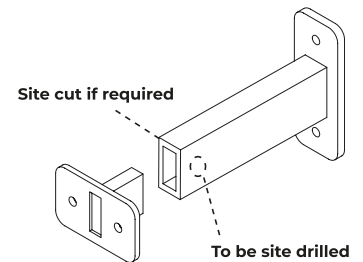

Mullion Bracket

Pipe (mm)	75 x 50	75 x 75	100 x 75	100 x 100	150 x 100	150 x 150
Flat Pipe Clip	RW32/14	RW33/14	RW43/14	RW44/14	RW64/14	RW66/14
MILL	3.43	3.43	3.50	3.50	3.89	3.89
PPC	3.98	3.98	4.05	4.05	4.44	4.44

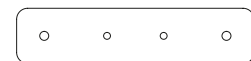

Flat Back Pipe Clip

Pipe (mm)	75 x 50	75 x 75	100 x 75	100 x 100	150 x 100	150 x 150
Concealed Pipe Clip	RW32/15	RW33/15	RW43/15	RW44/15	RW64/15	RW66/15
MILL	5.17	5.17	5.40	5.40	5.86	5.86
PPC	5.72	5.72	5.95	5.95	6.41	6.41

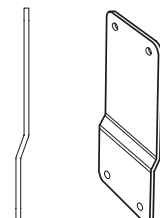

Concealed Pipe Clip

## PRICE LIST

### SQUARE & RECTANGULAR DOWNPIPE SYSTEM

#### CONNECTORS

Pipe (mm)	75 x 50	75 x 75	100 x 75	100 x 100	150 x 100	150 x 150
Connector	RW32/12	RW33/12	RW43/12	RW44/12	RW64/12	RW66/12
MILL	12.64	14.67	18.20	19.96	47.35	36.19
PPC	13.19	15.22	18.75	20.51	48.11	37.10

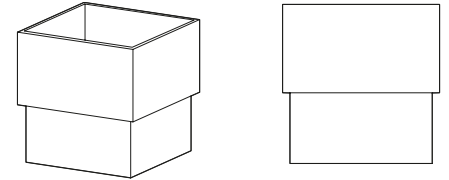

#### BENDS

Pipe (mm)	75 x 50	75 x 75	100 x 75	100 x 100	150 x 100	150 x 150
Bend	RW32/21	RW33/21	RW43/21	RW44/21	RW64/21	RW66/21
MILL	28.94	33.69	39.87	42.84	68.84	80.73
PPC	29.49	34.31	40.63	43.73	70.01	82.27

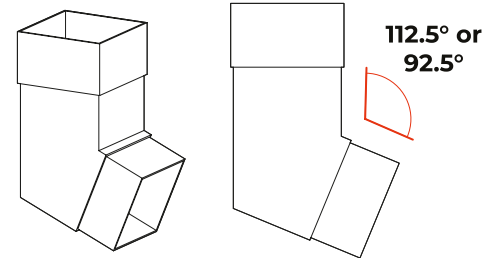

112.5° bend shown

NOTE: NORMALLY USED WITH A BRANCH

RECTANGULAR BENDS CAN ONLY BE USED AS A SIDE LEFT OR RIGHT  
NOT FORWARD OR REAR PROJECTING

#### PLINTH OFFSETS

Pipe (mm)	75 x 50	75 x 75	100 x 75	100 x 100	150 x 100	150 x 150
Offset Up To 150mm	RW32/23	RW33/23	RW43/23	RW44/23	RW64/23	RW66/23
MILL	66.27	74.41	80.76	89.02	123.80	145.44
PPC	67.59	76.12	82.53	91.39	126.72	148.88

NOTE: PLEASE STATE PROJECTION (P) SIZE

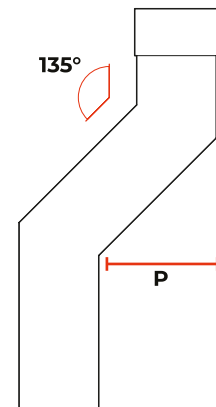

## PRICE LIST

### SQUARE & RECTANGULAR DOWNPIPE SYSTEM

#### SWAN NECKS

##### SWAN NECK 1 PIECE

Pipe (mm)	75 x 50	75 x 75	100 x 75	100 x 100	150 x 100	150 x 150
One Piece 300mm	RW32/25	RW33/25	RW43/25	RW44/25	RW64/25	RW66/25
MILL	66.80	74.51	81.43	91.49	120.74	178.82
PPC	68.32	76.07	83.74	94.25	124.13	183.05

NOTE: PLEASE STATE PROJECTION (P) SIZE

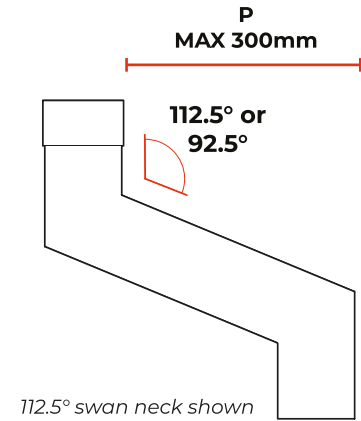

##### SWAN NECK 2 PIECE

Pipe (mm)	75 x 50	75 x 75	100 x 75	100 x 100	150 x 100	150 x 150
Two Piece 300mm	RW32/26	RW33/26	RW43/26	RW44/26	RW64/26	RW66/26
MILL	62.03	67.48	77.77	86.37	129.63	176.26
PPC	63.72	69.49	80.12	89.09	132.97	180.50
Two Piece 450mm	RW32/27	RW33/27	RW43/27	RW44/27	RW64/27	RW66/27
MILL	64.91	69.50	77.93	89.64	134.76	183.39
PPC	67.04	72.04	80.89	93.06	138.97	188.67
Two Piece 600mm	RW32/28	RW33/28	RW43/28	RW44/28	RW64/28	RW66/28
MILL	65.46	71.58	80.62	93.00	139.85	189.84
PPC	68.06	74.67	83.85	97.15	144.66	194.83
Two Piece 900mm	RW32/29	RW33/29	RW43/29	RW44/29	RW64/29	RW66/29
MILL	68.74	75.13	87.99	99.64	150.22	204.01
PPC	72.02	78.40	92.35	105.22	156.69	210.67
Two Piece 1200mm	RW32/30	RW33/30	RW43/30	RW44/30	RW64/30	RW66/30
MILL	72.22	79.25	92.27	106.47	160.88	220.11
PPC	76.37	83.44	97.85	113.53	169.06	230.76

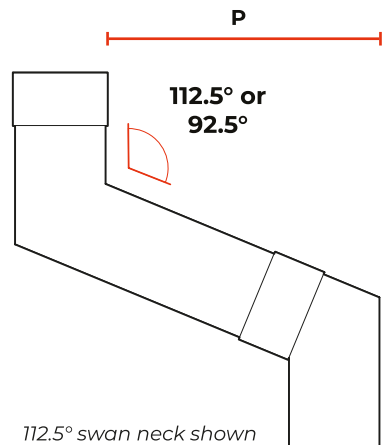

## PRICE LIST

### FIXINGS & SEALANTS

Code	Qty	Description	Price
GM1	25	Gutter Fixing 38 x 5.5 A2 Stainless Steel	4.56
GM2	100	Gutter Fixing 38 x 5.5 A2 Stainless Steel	13.86
GM3	200	Gutter Fixing 38 x 5.5 A2 Stainless Steel	26.90



GM1 - GM5

Code	Qty	Description	Price
GM201	25	4.8 x 14.7 All Aluminium sealed Rivet	3.38
GM202	100	4.8 x 14.7 All Aluminium sealed Rivet	12.46
GM203	200	4.8 x 14.7 All Aluminium sealed Rivet	23.38



GM201 - GM203

Code	Qty	Description	Price
GM610	25	6.3mm STRUCTURAL Aluminium Rivet	10.97
GM620	100	6.3mm STRUCTURAL Aluminium Rivet	39.11
GM630	200	6.3mm STRUCTURAL Aluminium Rivet	78.21



GM610 - GM620

Code	Qty	Description	Price
GM20	25	Downpipe Fixing 6 x 50 A2 Stainless Steel	9.81
GM21	100	Downpipe Fixing 6 x 50 A2 Stainless Steel	32.84



GM20 - GM21

Code	Qty	Description	Price
GM30	1	380ml Cartridge Silicone Sealant - Grey	11.00
GM32	1	1no 12mtr Reel Butyl Tape 12mm x 3mm	6.56
GM40	1	Touch Up Paint - Colour to match order	23.98
GM50	1	1no Drill Bit 4.8mm	2.06
GM51	1	1no Drill Bit 6.4mm	2.74



GM30



GM32



GM50 - GM60

Code	Qty	Description	Price
GM910	1	Standard Rainwater Rivet Gun	20.13
GM920	1	Professional Rivet Gun - Interchangeable collets for rain-water and structural rivets	115.19



GM910



GM920

## PRICE LIST

### CARRIAGE CHARGES

#### GUTTERS, DOWNPIPES & HOPPERS

TOTAL NET ORDER VALUE (EXCLUDING VAT)		PRICE
£0 - £99	BOXED UP TO 10KG	£15 Min Charge
£0 - £99	3M LENGTHS UP TO 10KGS	£30
£100 - £624		£40
£625 - £1249		£55
£1250 PLUS		FREE DELIVERY

Delivery Exclusions Apply:  
Please see the Charges  
section below

#### COPING, FASCIAS & SOFFITS

TOTAL NET ORDER VALUE (EXCLUDING VAT)	PRICE
£0 - £150	£40
£151 - £1249	£95
£1250 PLUS	FREE DELIVERY

Delivery Exclusions Apply:  
Please see the Charges  
section below

#### CHARGES

With a fleet of Guttercrest vehicles and outside couriers, we deliver all our aluminium products to your local builders merchant or direct to site.

##### SCOTTISH MAINLAND

Standard carriage charges apply on  
Postcode areas: DG, EH, G, KA, KY, TD

ALSO TO INCLUDE: DD1 - DD7, FK1 - FK7, FK9 - FK15,  
FK8 STERLING ONLY (Rest of FK8 will be price on application),  
KY1 - KY16, PA1 - PA19, PH1 - PH4, PH12 - PH14

All other Scottish Mainland, carriage price on application.

##### NON MAINLAND

For delivery to Northern Ireland, The Republic of Ireland  
and all offshore Islands, carriage Price on application.

##### EXPORT

Price on application.

Tel: +44 (0)1691 663300

Email: [info@guttercrest.co.uk](mailto:info@guttercrest.co.uk)

VAT will be charged at the appropriate rate.

