

GUTTERCREST

ALUMINIUM

VICTORIAN OGEE GUTTERS

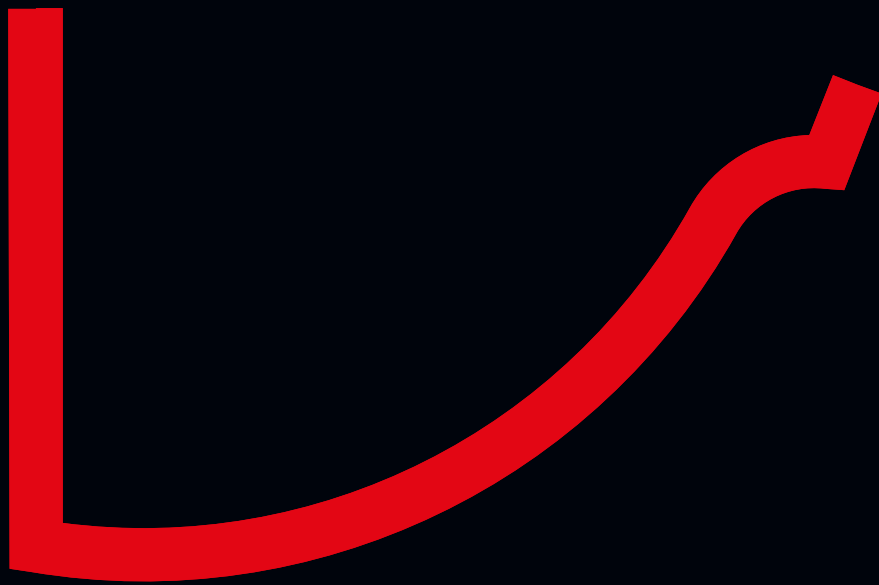

PRICE LIST

PRICE LIST

VICTORIAN OGEE GUTTER SYSTEM

STANDARD GUTTER LENGTHS

Gutter (mm)	110 x 50	120 x 60	130 x 60	160 x 75
3.0mtr	VOG1/1	VOG2/1	VOG3/1	VOG4/1
MILL	43.44	47.44	54.19	64.35
PPC	51.28	56.46	64.30	76.35
1.8mtr	VOG1/2	VOG2/2	VOG3/2	VOG4/2
MILL	30.00	32.63	37.00	43.48
PPC	34.71	38.05	43.07	50.68

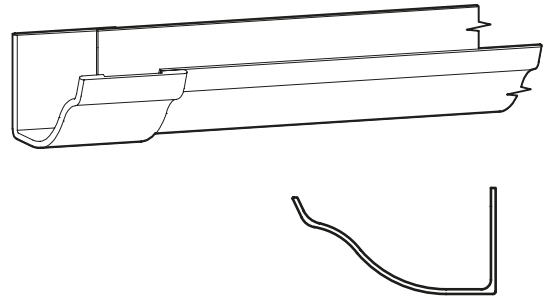

ANGLES - INTERNAL & EXTERNAL

Gutter (mm)	110 x 50	120 x 60	130 x 60	160 x 75
90° External	VOG1/3	VOG2/3	VOG3/3	VOG4/3
MILL	26.51	28.35	31.68	36.72
PPC	27.33	29.32	32.80	38.17
90° Internal	VOG1/4	VOG2/4	VOG3/4	VOG4/4
MILL	26.51	28.35	31.68	36.72
PPC	27.33	29.32	32.80	38.17
135° External	VOG1/5	VOG2/5	VOG3/5	VOG4/5
MILL	25.76	27.44	30.56	35.04
PPC	26.41	28.20	31.42	36.11
135° Internal	VOG1/6	VOG2/6	VOG3/6	VOG4/6
MILL	25.76	27.44	30.56	35.04
PPC	26.41	28.20	31.42	36.11
Irregular External	VOG1/7	VOG2/7	VOG3/7	VOG4/7
MILL	32.60	34.53	37.91	43.23
PPC	33.43	35.52	39.11	44.88
Irregular Internal	VOG1/8	VOG2/8	VOG3/8	VOG4/8
MILL	32.60	34.53	37.91	43.23
PPC	33.43	35.52	39.11	44.88

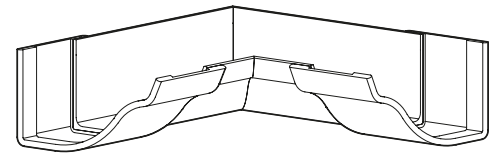

Internal Angle

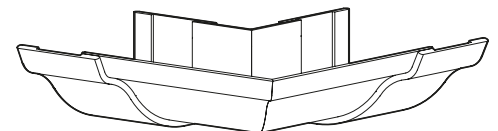

External Angle

STOP ENDS

Gutter (mm)	110 x 50	120 x 60	130 x 60	160 x 75
Stop End Right Hand	VOG1/10	VOG2/10	VOG3/10	VOG4/10
MILL	5.73	5.85	5.99	6.11
PPC	6.28	6.40	6.54	6.66
Stop End Left Hand	VOG1/11	VOG2/11	VOG3/11	VOG4/11
MILL	5.73	5.85	5.99	6.11
PPC	6.28	6.40	6.54	6.66

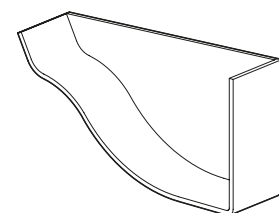

Right Hand Shown

NOTE: THESE ARE EXTERNAL STOP ENDS

PRICE LIST

VICTORIAN OGEE GUTTER SYSTEM

RUNNING OUTLETS - ROUND

Gutter (mm)	110 x 50	120 x 60	130 x 60	160 x 75
63mm Ø	VOG1/13	VOG2/13	VOG3/13	VOG4/13
MILL	23.67	24.94	28.43	29.15
PPC	24.33	25.70	29.28	30.16
75mm Ø	VOG1/14	VOG2/14	VOG3/14	VOG4/14
MILL	24.81	26.08	27.90	30.31
PPC	25.47	26.84	28.75	31.32
100mm Ø	VOG1/15	VOG2/15	VOG3/15	VOG4/15
MILL	-	-	33.77	36.17
PPC	-	-	34.62	37.18
125mm Ø	VOG1/16	VOG2/16	VOG3/16	VOG4/16
MILL	-	-	-	39.72
PPC	-	-	-	40.93

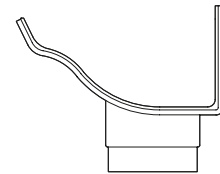
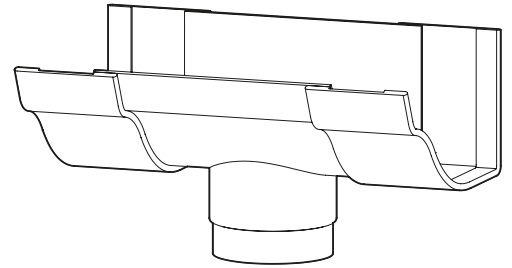

RUNNING OUTLETS - SQUARE & RECTANGULAR

Gutter (mm)	110 x 50	120 x 60	130 x 60	160 x 75
75 x 50mm	VOG1/18	VOG2/18	VOG3/18	VOG4/18
MILL	24.90	26.18	27.99	30.39
PPC	25.56	26.94	28.84	31.40
75 x 75mm	VOG1/19	VOG2/19	VOG3/19	VOG4/19
MILL	30.31	31.58	33.39	35.80
PPC	30.97	32.34	34.24	36.81
100 x 75mm	VOG1/20	VOG2/20	VOG3/20	VOG4/20
MILL	31.98	33.25	35.06	37.47
PPC	32.64	34.01	35.91	38.48
100 x 100mm	VOG1/21	VOG2/21	VOG3/21	VOG4/21
MILL	-	-	36.31	38.71
PPC	-	-	37.16	39.72
150 x 100mm	VOG1/22	VOG2/22	VOG3/22	VOG4/22
MILL	-	-	44.13	46.67
PPC	-	-	45.15	47.88

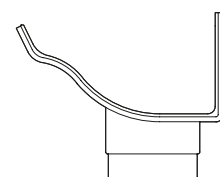
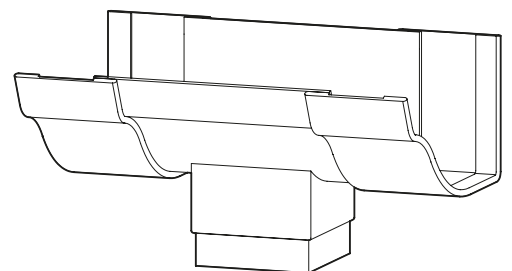

PRICE LIST

VICTORIAN OGEE GUTTER SYSTEM

STOPEND OUTLETS RIGHT HAND & LEFT HAND - ROUND

Gutter (mm)	110 x 50	120 x 60	130 x 60	160 x 75
63mm Ø	VOG1/13	VOG2/13	VOG3/13	VOG4/13
MILL	23.67	24.94	28.43	29.15
PPC	24.33	25.70	29.28	30.16
75mm Ø	VOG1/14	VOG2/14	VOG3/14	VOG4/14
MILL	24.81	26.08	27.90	30.31
PPC	25.47	26.84	28.75	31.32
100mm Ø	VOG1/15	VOG2/15	VOG3/15	VOG4/15
MILL	-	-	33.77	36.17
PPC	-	-	34.62	37.18
125mm Ø	VOG1/16	VOG2/16	VOG3/16	VOG4/16
MILL	-	-	-	39.72
PPC	-	-	-	40.93

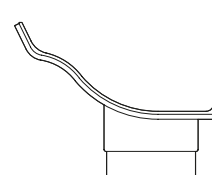

STOPEND OUTLETS RIGHT HAND & LEFT HAND - SQUARE & RECTANGULAR

Gutter (mm)	110 x 50	120 x 60	130 x 60	160 x 75
75 x 50mm	VOG1/18	VOG2/18	VOG3/18	VOG4/18
MILL	24.90	26.18	27.99	30.39
PPC	25.56	26.94	28.84	31.40
75 x 75mm	VOG1/19	VOG2/19	VOG3/19	VOG4/19
MILL	30.31	31.58	33.39	35.80
PPC	30.97	32.34	34.24	36.81
100 x 75mm	VOG1/20	VOG2/20	VOG3/20	VOG4/20
MILL	31.98	33.25	35.06	37.47
PPC	32.64	34.01	35.91	38.48
100 x 100mm	VOG1/21	VOG2/21	VOG3/21	VOG4/21
MILL	-	-	36.31	38.71
PPC	-	-	37.16	39.72
150 x 100mm	VOG1/22	VOG2/22	VOG3/22	VOG4/22
MILL	-	-	44.13	46.67
PPC	-	-	45.15	47.88

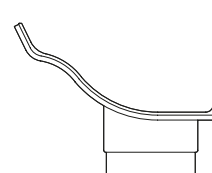

PRICE LIST

VICTORIAN OGEE GUTTER SYSTEM

RAFTER & MORTAR BRACKETS

Gutter (mm)	110 x 50	120 x 60	130 x 60	160 x 75
Side Rafter	VOG1/29	VOG2/29	VOG3/29	VOG4/29
MILL	9.48	9.48	9.48	9.48
PPC	10.03	10.03	10.03	10.03
Top Rafter	VOG1/30	VOG2/30	VOG3/30	VOG4/30
MILL	8.23	8.23	8.23	8.23
PPC	8.78	8.78	8.78	8.78
Mortar	VOG1/31	VOG2/31	VOG3/31	VOG4/31
MILL	10.35	10.35	10.35	10.35
PPC	10.90	10.90	10.90	10.90

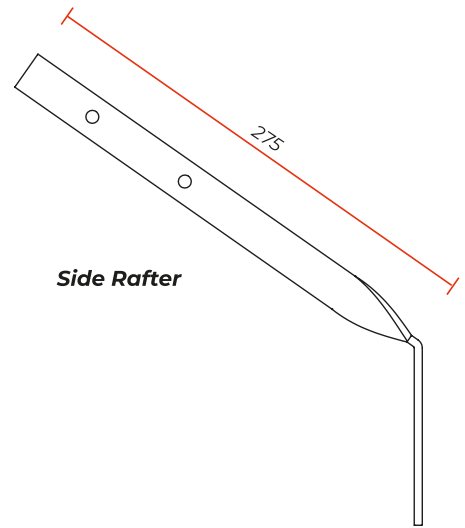

Side Rafter

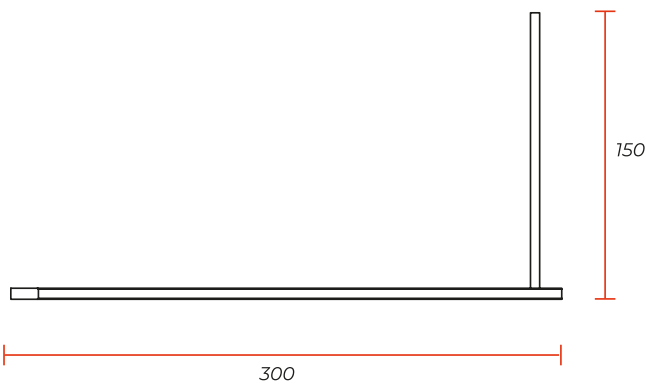

Standard Mortar Bracket

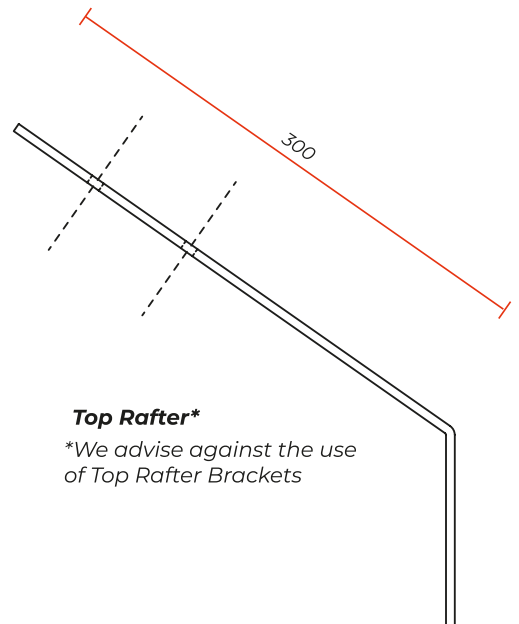

Top Rafter*

*We advise against the use of Top Rafter Brackets

PRICE LIST

FIXINGS & SEALANTS

Code	Qty	Description	Price
GM1	25	Gutter Fixing 38 x 5.5 A2 Stainless Steel	4.56
GM2	100	Gutter Fixing 38 x 5.5 A2 Stainless Steel	13.86
GM3	200	Gutter Fixing 38 x 5.5 A2 Stainless Steel	26.90



GM1 - GM5

Code	Qty	Description	Price
GM201	25	4.8 x 14.7 All Aluminium sealed Rivet	3.38
GM202	100	4.8 x 14.7 All Aluminium sealed Rivet	12.46
GM203	200	4.8 x 14.7 All Aluminium sealed Rivet	23.38



GM201 - GM203

Code	Qty	Description	Price
GM610	25	6.3mm STRUCTURAL Aluminium Rivet	10.97
GM620	100	6.3mm STRUCTURAL Aluminium Rivet	39.11
GM630	200	6.3mm STRUCTURAL Aluminium Rivet	78.21



GM610 - GM620

Code	Qty	Description	Price
GM20	25	Downpipe Fixing 6 x 50 A2 Stainless Steel	9.81
GM21	100	Downpipe Fixing 6 x 50 A2 Stainless Steel	32.84



GM20 - GM21

Code	Qty	Description	Price
GM30	1	380ml Cartridge Silicone Sealant - Grey	11.00
GM32	1	1no 12mtr Reel Butyl Tape 12mm x 3mm	6.56
GM40	1	Touch Up Paint - Colour to match order	23.98
GM50	1	1no Drill Bit 4.8mm	2.06
GM51	1	1no Drill Bit 6.4mm	2.74



GM30



GM32



GM50 - GM60

Code	Qty	Description	Price
GM910	1	Standard Rainwater Rivet Gun	20.13
GM920	1	Professional Rivet Gun - Interchangeable collets for rain-water and structural rivets	115.19



GM910



GM920

PRICE LIST

CARRIAGE CHARGES

GUTTERS, DOWNPIPES & HOPPERS

TOTAL NET ORDER VALUE (EXCLUDING VAT)		PRICE
£0 - £99	BOXED UP TO 10KG	£15 Min Charge
£0 - £99	3M LENGTHS UP TO 10KGS	£30
£100 - £624		£40
£625 - £1249		£55
£1250 PLUS		FREE DELIVERY

Delivery Exclusions Apply:
Please see the Charges
section below

COPING, FASCIAS & SOFFITS

TOTAL NET ORDER VALUE (EXCLUDING VAT)	PRICE
£0 - £150	£40
£151 - £1249	£95
£1250 PLUS	FREE DELIVERY

Delivery Exclusions Apply:
Please see the Charges
section below

CHARGES

With a fleet of Guttercrest vehicles and outside couriers, we deliver all our aluminium products to your local builders merchant or direct to site.

SCOTTISH MAINLAND

Standard carriage charges apply on
Postcode areas: DG, EH, G, KA, KY, TD

ALSO TO INCLUDE: DD1 - DD7, FK1 - FK7, FK9 - FK15,
FK8 STERLING ONLY (Rest of FK8 will be price on application),
KY1 - KY16, PA1 - PA19, PH1 - PH4, PH12 - PH14

All other Scottish Mainland, carriage price on application.

NON MAINLAND

For delivery to Northern Ireland, The Republic of Ireland
and all offshore Islands, carriage Price on application.

EXPORT

Price on application.

Tel: +44 (0)1691 663300

Email: info@guttercrest.co.uk

VAT will be charged at the appropriate rate.

