

GUTTERCREST

ALUMINIUM

BEADED DEEP FLOW GUTTERS

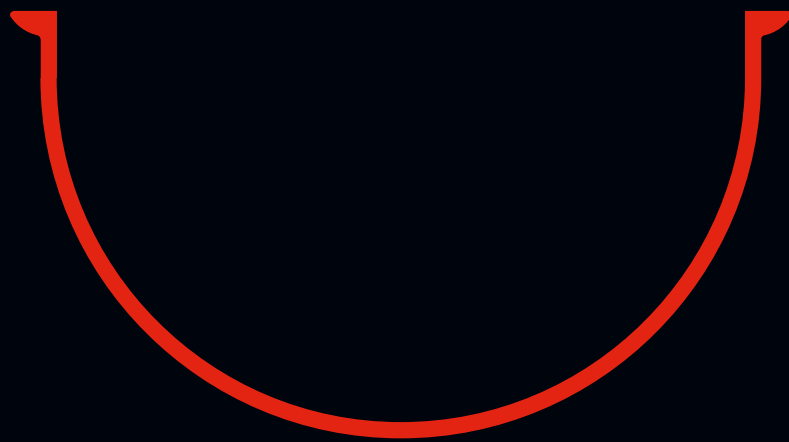

PRICE LIST

PRICE LIST

BEADED DEEP FLOW GUTTER SYSTEM

STANDARD GUTTER LENGTHS

Gutter (mm)	100	125	150
3.0mtr	BDF1/1	BDF2/1	BDF3/1
MILL	36.55	50.40	68.65
PPC	44.25	60.47	81.14
1.8mtr	BDF1/2	BDF2/2	BDF3/2
MILL	23.94	32.47	43.73
PPC	28.63	38.52	51.23

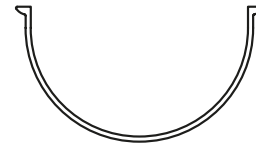
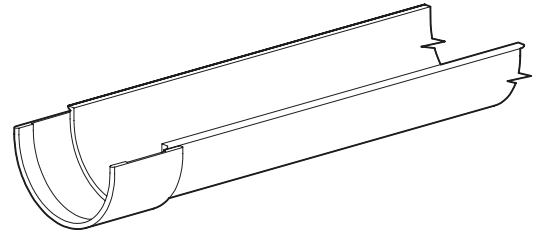

ANGLES - INTERNAL & EXTERNAL

Gutter (mm)	100	125	150
90°	BDF1/3	BDF2/3	BDF3/3
MILL	19.99	23.28	27.47
PPC	20.80	24.40	28.98
135°	BDF1/5	BDF2/5	BDF3/5
MILL	19.99	23.28	27.47
PPC	20.80	24.40	28.98
Irregular	BDF1/7	BDF2/7	BDF3/7
MILL	29.80	33.73	39.39
PPC	30.65	34.93	41.11

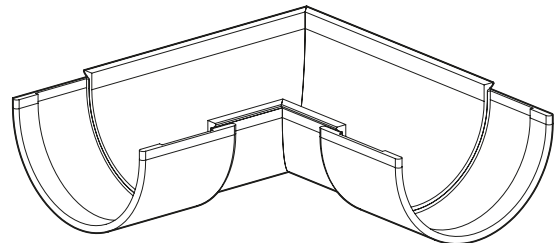

STOP ENDS

Gutter (mm)	100	125	150
Stop End	BDF1/9	BDF2/9	BDF3/9
MILL	5.99	6.11	6.75
PPC	6.54	6.66	7.30

NOTE: THESE ARE EXTERNAL STOP ENDS

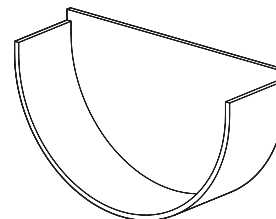

PRICE LIST

BEADED DEEP FLOW GUTTER SYSTEM

RUNNING OUTLETS - ROUND

Gutter (mm)	100	125	150
63mm Ø	BDF1/13	BDF2/13	BDF3/13
MILL	26.71	28.91	31.58
PPC	27.37	29.76	32.63
75mm Ø	BDF1/14	BDF2/14	BDF3/14
MILL	27.73	29.93	32.60
PPC	28.39	30.78	33.65
100mm Ø	BDF1/15	BDF2/15	BDF3/15
MILL	-	32.56	35.22
PPC	-	33.41	36.27
125mm Ø	BDF1/16	BDF2/16	BDF3/16
MILL	-	-	38.54
PPC	-	-	39.80

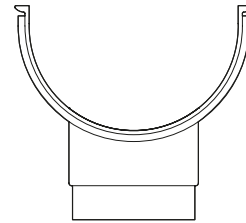
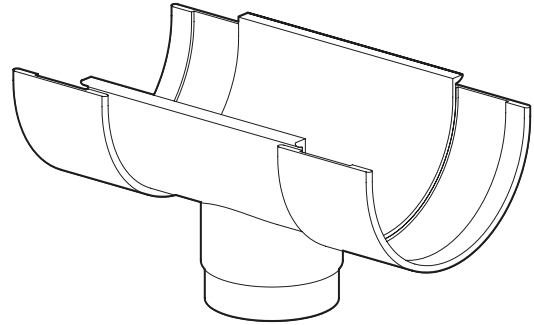

RUNNING OUTLETS - SQUARE & RECTANGULAR

Gutter (mm)	100	125	150
75 x 50mm	BDF1/18	BDF2/18	BDF3/18
MILL	28.06	30.26	32.92
PPC	28.72	31.11	33.97
75 x 75mm	BDF1/19	BDF2/19	BDF3/19
MILL	29.36	31.57	34.23
PPC	30.02	32.42	35.28
100 x 75mm	BDF1/20	BDF2/20	BDF3/20
MILL	30.94	33.14	35.81
PPC	31.60	33.99	36.86
100 x 100mm	BDF1/21	BDF2/21	BDF3/21
MILL	-	35.09	37.75
PPC	-	35.94	38.80
150 x 100mm	BDF1/22	BDF2/22	BDF3/22
MILL	-	36.84	41.95
PPC	-	37.86	43.21

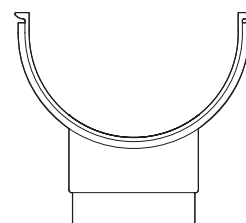
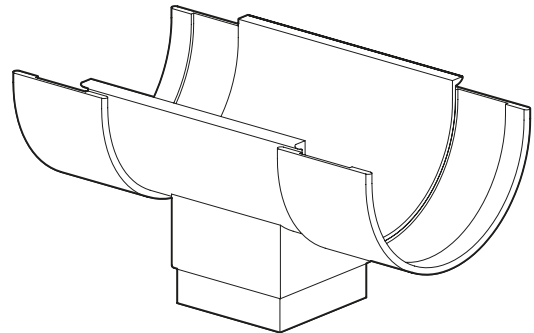

PRICE LIST

BEADED DEEP FLOW GUTTER SYSTEM

STOPEND OUTLETS - ROUND

Gutter (mm)	100	125	150
63mm Ø	BDF1/130	BDF2/130	BDF3/130
MILL	30.09	32.10	35.16
PPC	30.70	32.71	36.21
75mm Ø	BDF1/140	BDF2/140	BDF3/140
MILL	31.13	33.07	35.98
PPC	31.79	33.68	36.74
100mm Ø	BDF1/150	BDF2/150	BDF3/150
MILL	-	35.69	38.61
PPC	-	36.30	39.37
125mm Ø	BDF1/160	BDF2/160	BDF3/160
MILL	-	-	41.90
PPC	-	-	42.81

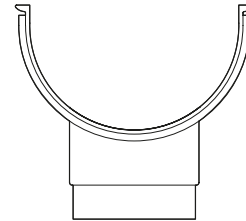
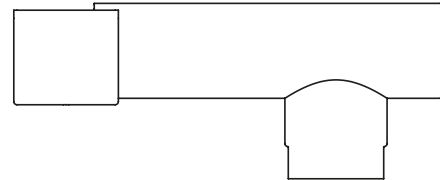

STOPEND OUTLETS - SQUARE & RECTANGULAR

Gutter (mm)	100	125	150
75 x 50mm	BDF1/180	BDF2/180	BDF3/180
MILL	31.46	33.40	36.32
PPC	32.12	34.01	37.08
75 x 75mm	BDF1/190	BDF2/190	BDF3/190
MILL	32.76	34.70	37.62
PPC	33.42	35.31	38.38
100 x 75mm	BDF1/200	BDF2/200	BDF3/200
MILL	34.34	36.28	39.20
PPC	35.00	36.89	39.96
100 x 100mm	BDF1/210	BDF2/210	BDF3/210
MILL	-	38.22	41.14
PPC	-	38.83	41.90
150 x 100mm	BDF1/220	BDF2/220	BDF3/220
MILL	-	42.90	45.31
PPC	-	42.90	46.22

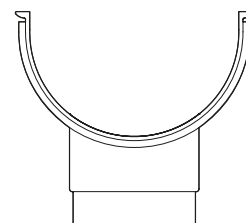
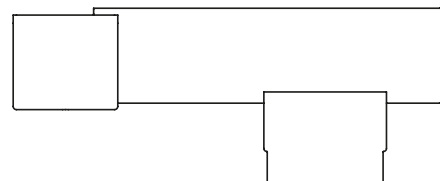

PRICE LIST

BEADED DEEP FLOW GUTTER SYSTEM

FASCIA BRACKETS

Gutter (mm)	100	125	150
Bracket	BDF1/28	BDF2/28	BDF3/28
MILL	3.32	3.92	4.36
PPC	3.87	4.47	4.91

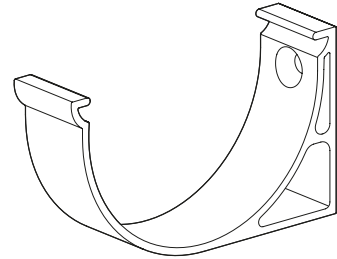

RAFTER & MORTAR BRACKETS

Gutter (mm)	100	125	150
Side Rafter	BDF1/29	BDF2/29	BDF3/29
MILL	7.46	7.46	7.46
PPC	8.01	8.01	8.01
Top Rafter	BDF1/30	BDF2/30	BDF3/30
MILL	6.20	6.20	6.20
PPC	6.75	6.75	6.75
Mortar	BDF1/31	BDF2/31	BDF3/31
MILL	9.41	9.41	9.41
PPC	9.96	9.96	9.96

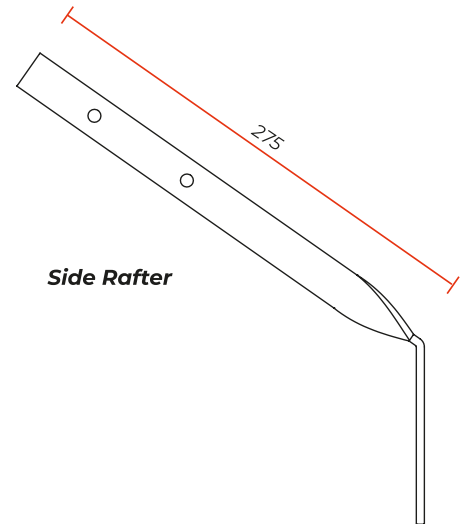

Side Rafter

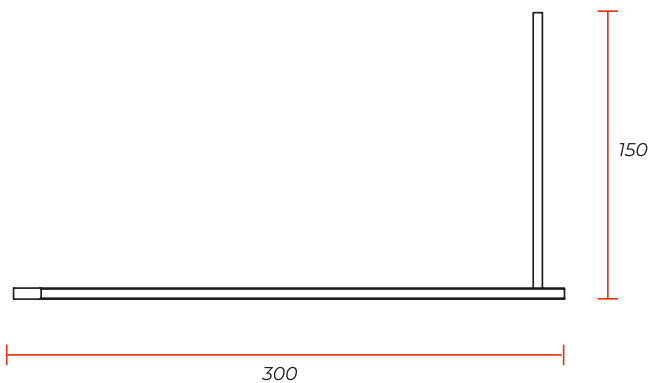

Standard Mortar Bracket

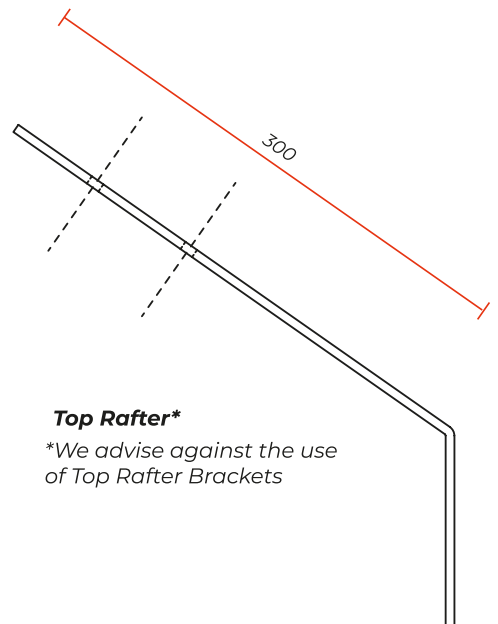

Top Rafter*

*We advise against the use of Top Rafter Brackets

PRICE LIST

FIXINGS & SEALANTS

Code	Qty	Description	Price
GM1	25	Gutter Fixing 38 x 5.5 A2 Stainless Steel	4.56
GM2	100	Gutter Fixing 38 x 5.5 A2 Stainless Steel	13.86
GM3	200	Gutter Fixing 38 x 5.5 A2 Stainless Steel	26.90



GM1 - GM5

Code	Qty	Description	Price
GM201	25	4.8 x 14.7 All Aluminium sealed Rivet	3.38
GM202	100	4.8 x 14.7 All Aluminium sealed Rivet	12.46
GM203	200	4.8 x 14.7 All Aluminium sealed Rivet	23.38



GM201 - GM203

Code	Qty	Description	Price
GM610	25	6.3mm STRUCTURAL Aluminium Rivet	10.97
GM620	100	6.3mm STRUCTURAL Aluminium Rivet	39.11
GM630	200	6.3mm STRUCTURAL Aluminium Rivet	78.21



GM610 - GM620

Code	Qty	Description	Price
GM20	25	Downpipe Fixing 6 x 50 A2 Stainless Steel	9.81
GM21	100	Downpipe Fixing 6 x 50 A2 Stainless Steel	32.84



GM20 - GM21

Code	Qty	Description	Price
GM30	1	380ml Cartridge Silicone Sealant - Grey	11.00
GM32	1	1no 12mtr Reel Butyl Tape 12mm x 3mm	6.56
GM40	1	Touch Up Paint - Colour to match order	23.98
GM50	1	1no Drill Bit 4.8mm	2.06
GM51	1	1no Drill Bit 6.4mm	2.74



GM30



GM32



GM50 - GM60

Code	Qty	Description	Price
GM910	1	Standard Rainwater Rivet Gun	20.13
GM920	1	Professional Rivet Gun - Interchangeable collets for rain-water and structural rivets	115.19



GM910



GM920

PRICE LIST

CARRIAGE CHARGES

GUTTERS, DOWNPIPES & HOPPERS

TOTAL NET ORDER VALUE (EXCLUDING VAT)		PRICE
£0 - £99	BOXED UP TO 10KG	£15 Min Charge
£0 - £99	3M LENGTHS UP TO 10KGS	£30
£100 - £624		£40
£625 - £1249		£55
£1250 PLUS		FREE DELIVERY

Delivery Exclusions Apply:
Please see the Charges
section below

COPING, FASCIAS & SOFFITS

TOTAL NET ORDER VALUE (EXCLUDING VAT)	PRICE
£0 - £150	£40
£151 - £1249	£95
£1250 PLUS	FREE DELIVERY

Delivery Exclusions Apply:
Please see the Charges
section below

CHARGES

With a fleet of Guttercrest vehicles and outside couriers, we deliver all our aluminium products to your local builders merchant or direct to site.

SCOTTISH MAINLAND

Standard carriage charges apply on
Postcode areas: DG, EH, G, KA, KY, TD

ALSO TO INCLUDE: DD1 - DD7, FK1 - FK7, FK9 - FK15,
FK8 STERLING ONLY (Rest of FK8 will be price on application),
KY1 - KY16, PA1 - PA19, PH1 - PH4, PH12 - PH14

All other Scottish Mainland, carriage price on application.

NON MAINLAND

For delivery to Northern Ireland, The Republic of Ireland
and all offshore Islands, carriage Price on application.

EXPORT

Price on application.

Tel: +44 (0)1691 663300

Email: info@guttercrest.co.uk

VAT will be charged at the appropriate rate.

