

GUTTERCREST

ALUMINIUM

**MOULDED OGEE SMALL
GUTTERS**



PRICE LIST

PRICE LIST

MOULDED OGEE GUTTER SYSTEM - SMALL SIZES

STANDARD GUTTER LENGTHS

Gutter (mm)	100 x 75	125 x 100	150 x 100
3.0mtr	MOG1/1	MOG2/1	MOG3/1
MILL	53.27	75.08	93.65
PPC	61.05	85.24	104.50
1.8mtr	MOG1/2	MOG2/2	MOG3/2
MILL	37.09	51.65	63.44
PPC	41.76	57.75	69.96

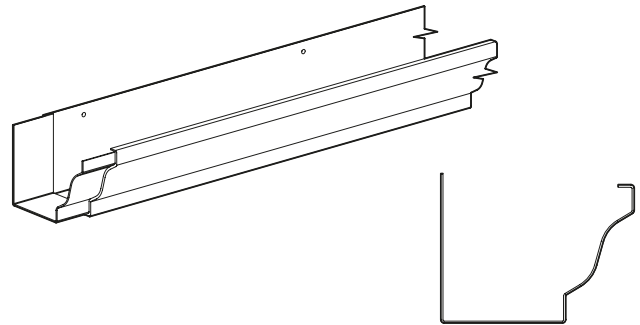

ANGLES - INTERNAL & EXTERNAL

Gutter (mm)	100 x 75	125 x 100	150 x 100
90° External	MOG1/3	MOG2/3	MOG3/3
MILL	35.29	33.59	52.24
PPC	36.05	34.66	53.48
90° Internal	MOG1/4	MOG2/4	MOG3/4
MILL	35.29	33.59	52.24
PPC	36.05	34.66	53.48
135° External	MOG1/5	MOG2/5	MOG3/5
MILL	34.53	32.25	50.21
PPC	35.13	33.08	51.13
135° Internal	MOG1/6	MOG2/6	MOG3/6
MILL	34.53	32.25	50.21
PPC	35.13	33.08	51.13
Irregular External	MOG1/7	MOG2/7	MOG3/7
MILL	45.50	51.28	65.18
PPC	46.29	52.47	66.63
Irregular Internal	MOG1/8	MOG2/8	MOG3/8
MILL	45.50	51.28	65.18
PPC	46.29	52.47	66.63

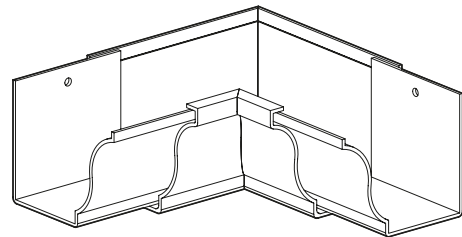

Internal Angle

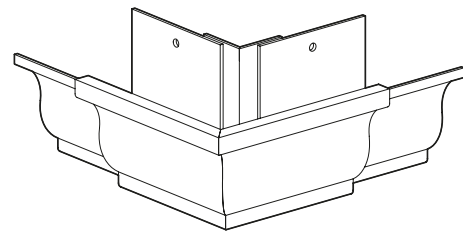

External Angle

STOP ENDS

Gutter (mm)	100 x 75	125 x 100	150 x 100
Stop End Right Hand	MOG1/10	MOG2/10	MOG3/10
MILL	5.99	6.24	6.75
PPC	6.54	6.79	7.30
Stop End Left Hand	MOG1/11	MOG2/11	MOG3/11
MILL	5.99	6.24	6.75
PPC	6.54	6.79	7.30

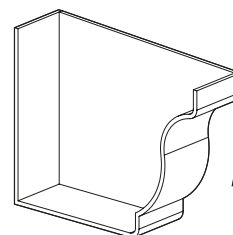

Right Hand shown

NOTE: THESE ARE INTERNAL STOP ENDS

PRICE LIST

MOULDED OGEE GUTTER SYSTEM - SMALL SIZES

SLEEVE OUTLETS - ROUND

Gutter (mm)	100 x 75	125 x 100	150 x 100
63mm Ø	MOG1/SO13	MOG2/SO13	MOG3/SO13
MILL	-	10.91	10.91
PPC	-	11.46	11.46
75mm Ø	MOG1/SO14	MOG2/SO14	MOG3/SO14
MILL	-	-	10.91
PPC	-	-	11.46
100mm Ø	MOG1/SO15	MOG2/SO15	MOG3/SO15
MILL	-	-	-
PPC	-	-	-
125mm Ø	MOG1/SO16	MOG2/SO16	MOG3/SO16
MILL	-	-	-
PPC	-	-	-

Please Note

Sleeve Outlets can be used in place of Running Outlets giving increased flexibility and cost efficiency.

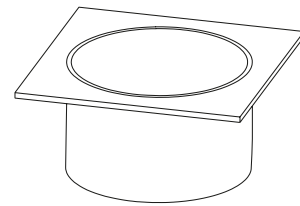

SLEEVE OUTLETS - SQUARE & RECTANGULAR

Gutter (mm)	100 x 75	125 x 100	150 x 100
75 x 50mm	MOG1/SO18	MOG2/SO18	MOG3/SO18
MILL	-	10.91	10.91
PPC	-	11.46	11.46
75 x 75mm	MOG1/SO19	MOG2/SO19	MOG3/SO19
MILL	-	-	10.91
PPC	-	-	11.46
100 x 75mm	MOG1/SO20	MOG2/SO20	MOG3/SO20
MILL	-	-	10.91
PPC	-	-	11.46
100 x 100mm	MOG1/SO21	MOG2/SO21	MOG3/SO21
MILL	-	-	-
PPC	-	-	-
150 x 100mm	MOG1/SO22	MOG2/SO22	MOG3/SO22
MILL	-	-	-
PPC	-	-	-

Please Note

Sleeve Outlets can be used in place of Running Outlets giving increased flexibility and cost efficiency.

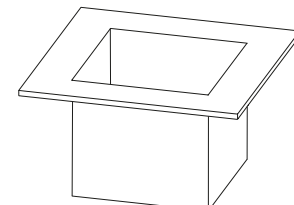

PRICE LIST

MOULDED OGEE GUTTER SYSTEM - SMALL SIZES

RUNNING OUTLETS - ROUND

Gutter (mm)	100 x 75	125 x 100	150 x 100
63mm Ø	MOG1/13	MOG2/13	MOG3/13
MILL	35.55	31.80	41.23
PPC	36.20	32.65	42.14
75mm Ø	MOG1/14	MOG2/14	MOG3/14
MILL	36.68	35.21	42.36
PPC	37.33	36.06	43.27
100mm Ø	MOG1/15	MOG2/15	MOG3/15
MILL	-	37.80	48.21
PPC	-	38.65	49.12
125mm Ø	MOG1/16	MOG2/16	MOG3/16
MILL	-	-	52.34
PPC	-	-	53.44

Please Note

Sleeve Outlets can be used in place of Running Outlets giving increased flexibility and cost efficiency.

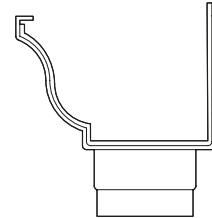
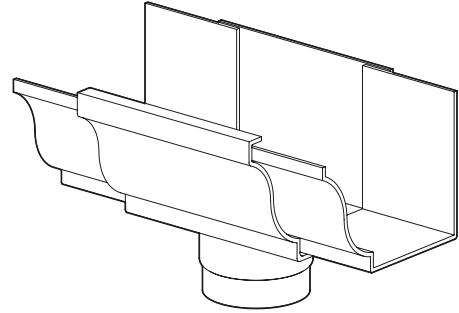

RUNNING OUTLETS - SQUARE & RECTANGULAR

Gutter (mm)	100 x 75	125 x 100	150 x 100
75 x 50mm	MOG1/18	MOG2/18	MOG3/18
MILL	36.79	31.54	42.46
PPC	37.44	32.39	43.37
75 x 75mm	MOG1/19	MOG2/19	MOG3/19
MILL	42.16	36.90	43.74
PPC	42.81	37.75	44.65
100 x 75mm	MOG1/20	MOG2/20	MOG3/20
MILL	43.80	38.68	45.24
PPC	44.45	39.53	46.15
100 x 100mm	MOG1/21	MOG2/21	MOG3/21
MILL	-	39.78	50.19
PPC	-	40.63	51.10
150 x 100mm	MOG1/22	MOG2/22	MOG3/22
MILL	-	41.89	59.83
PPC	-	42.91	60.93

Please Note

Sleeve Outlets can be used in place of Running Outlets giving increased flexibility and cost efficiency.

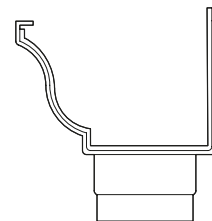
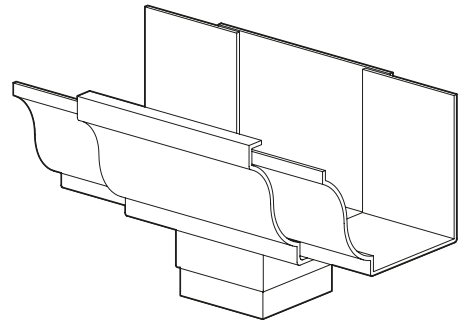

PRICE LIST

MOULDED OGEE GUTTER SYSTEM - SMALL SIZES

STOPEND OUTLETS RIGHT HAND & LEFT HAND - ROUND

Gutter (mm)	Right Hand Stop End Outlets			Left Hand Stop End Outlets		
	100 x 75	125 x 100	150 x 100	100 x 75	125 x 100	150 x 100
63mm Ø	MOG1/130	MOG2/130	MOG3/130	MOG1/131	MOG2/131	MOG3/131
MILL	35.44	31.90	41.29	35.44	31.90	41.29
PPC	36.29	32.75	42.14	36.29	32.75	42.14
75mm Ø	MOG1/140	MOG2/140	MOG3/140	MOG1/141	MOG2/141	MOG3/141
MILL	37.86	35.32	46.13	37.86	35.32	46.13
PPC	38.71	36.17	46.98	38.71	36.17	46.98
100mm Ø	MOG1/150	MOG2/150	MOG3/150	MOG1/151	MOG2/151	MOG3/151
MILL	-	37.34	51.98	-	37.34	51.98
PPC	-	37.34	52.83	-	37.34	52.83
125mm Ø	MOG1/160	MOG2/160	MOG3/160	MOG1/161	MOG2/161	MOG3/161
MILL	-	-	52.44	-	-	52.44
PPC	-	-	53.54	-	-	53.54

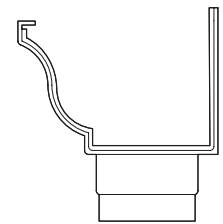

Please Note

Sleeve Outlets can sometimes be used in place of Running or Stop End Outlets giving increased flexibility and cost efficiency.

STOPEND OUTLETS RIGHT HAND & LEFT HAND - SQUARE & RECTANGULAR

Gutter (mm)	Right Hand Stop End Outlets			Left Hand Stop End Outlets		
	100 x 75	125 x 100	150 x 100	100 x 75	125 x 100	150 x 100
75 x 50mm	MOG1/180	MOG2/180	MOG3/180	MOG1/181	MOG2/181	MOG3/181
MILL	36.56	31.27	42.57	36.56	31.27	42.57
PPC	37.21	32.12	43.48	37.21	32.12	43.48
75 x 75mm	MOG1/190	MOG2/190	MOG3/190	MOG1/191	MOG2/191	MOG3/191
MILL	41.92	32.58	47.52	41.92	32.58	47.52
PPC	42.57	33.43	48.37	42.57	33.43	48.37
100 x 75mm	MOG1/200	MOG2/200	MOG3/200	MOG1/201	MOG2/201	MOG3/201
MILL	43.56	34.15	49.01	43.56	34.15	49.01
PPC	44.21	35.00	49.86	44.21	35.00	49.86
100 x 100mm	MOG1/210	MOG2/210	MOG3/210	MOG1/211	MOG2/211	MOG3/211
MILL	-	39.89	50.29	-	39.89	50.29
PPC	-	40.74	51.20	-	40.74	51.20

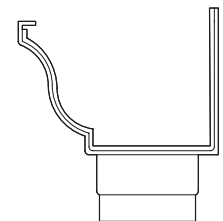

Please Note

Sleeve Outlets can sometimes be used in place of Running or Stop End Outlets giving increased flexibility and cost efficiency.

PRICE LIST

MOULDED OGEE GUTTER SYSTEM - SMALL SIZES

RAFTER & MORTAR BRACKETS

Gutter (mm)	100 x 75	125 x 100	150 x 100
Side Rafter	MOG1/29	MOG2/29	MOG3/29
MILL	7.46	7.46	7.46
PPC	8.01	8.01	8.01
Top Rafter	MOG1/30	MOG2/30	MOG3/30
MILL	6.20	6.20	6.20
PPC	6.75	6.75	6.75
Mortar	MOG1/31	MOG2/31	MOG3/31
MILL	9.41	9.41	9.41
PPC	9.96	9.96	9.96

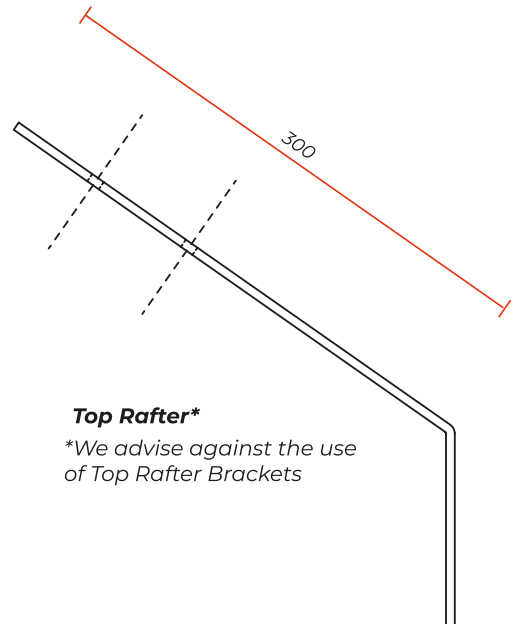
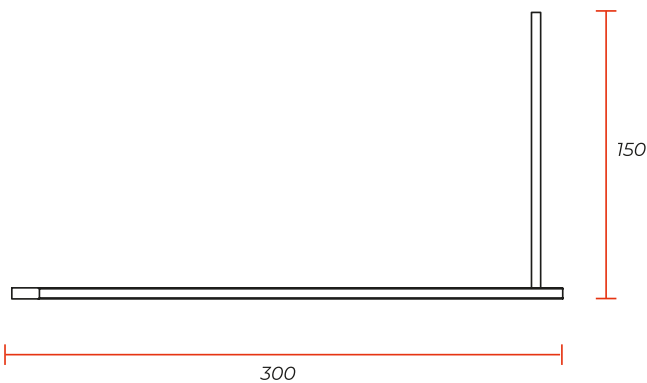
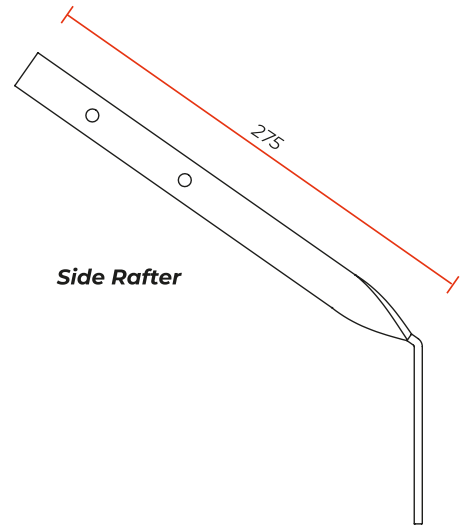

PRICE LIST

FIXINGS & SEALANTS

Code	Qty	Description	Price
GM1	25	Gutter Fixing 38 x 5.5 A2 Stainless Steel	4.56
GM2	100	Gutter Fixing 38 x 5.5 A2 Stainless Steel	13.86
GM3	200	Gutter Fixing 38 x 5.5 A2 Stainless Steel	26.90



GM1 - GM5

Code	Qty	Description	Price
GM201	25	4.8 x 14.7 All Aluminium sealed Rivet	3.38
GM202	100	4.8 x 14.7 All Aluminium sealed Rivet	12.46
GM203	200	4.8 x 14.7 All Aluminium sealed Rivet	23.38



GM201 - GM203

Code	Qty	Description	Price
GM610	25	6.3mm STRUCTURAL Aluminium Rivet	10.97
GM620	100	6.3mm STRUCTURAL Aluminium Rivet	39.11
GM630	200	6.3mm STRUCTURAL Aluminium Rivet	78.21



GM610 - GM620

Code	Qty	Description	Price
GM20	25	Downpipe Fixing 6 x 50 A2 Stainless Steel	9.81
GM21	100	Downpipe Fixing 6 x 50 A2 Stainless Steel	32.84



GM20 - GM21

Code	Qty	Description	Price
GM30	1	380ml Cartridge Silicone Sealant - Grey	11.00
GM32	1	1no 12mtr Reel Butyl Tape 12mm x 3mm	6.56
GM40	1	Touch Up Paint - Colour to match order	23.98
GM50	1	1no Drill Bit 4.8mm	2.06
GM51	1	1no Drill Bit 6.4mm	2.74



GM30



GM32



GM50 - GM60

Code	Qty	Description	Price
GM910	1	Standard Rainwater Rivet Gun	20.13
GM920	1	Professional Rivet Gun - Interchangeable collets for rain-water and structural rivets	115.19



GM910



GM920

PRICE LIST

CARRIAGE CHARGES

GUTTERS, DOWNPIPES & HOPPERS

TOTAL NET ORDER VALUE (EXCLUDING VAT)		PRICE
£0 - £99	BOXED UP TO 10KG	£15 Min Charge
£0 - £99	3M LENGTHS UP TO 10KGS	£30
£100 - £624		£40
£625 - £1249		£55
£1250 PLUS		FREE DELIVERY

Delivery Exclusions Apply:
Please see the Charges
section below

COPING, FASCIAS & SOFFITS

TOTAL NET ORDER VALUE (EXCLUDING VAT)	PRICE
£0 - £150	£40
£151 - £1249	£95
£1250 PLUS	FREE DELIVERY

Delivery Exclusions Apply:
Please see the Charges
section below

CHARGES

With a fleet of Guttercrest vehicles and outside couriers, we deliver all our aluminium products to your local builders merchant or direct to site.

SCOTTISH MAINLAND

Standard carriage charges apply on
Postcode areas: DG, EH, G, KA, KY, TD

ALSO TO INCLUDE: DD1 - DD7, FK1 - FK7, FK9 - FK15,
FK8 STERLING ONLY (Rest of FK8 will be price on application),
KY1 - KY16, PA1 - PA19, PH1 - PH4, PH12 - PH14

All other Scottish Mainland, carriage price on application.

NON MAINLAND

For delivery to Northern Ireland, The Republic of Ireland
and all offshore Islands, carriage Price on application.

EXPORT

Price on application.

Tel: +44 (0)1691 663300

Email: info@guttercrest.co.uk

VAT will be charged at the appropriate rate.

