

# GUTTERCREST

## ALUMINIUM

### SQUARE & RECTANGLE DOWNPIPES



75 X 75 mm  
3 X 3"



75 X 50 mm  
3 X 2"



100 X 100 mm  
4 X 4"

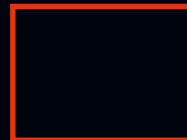

100 X 75 mm  
4 X 3"



150 X 150 mm  
6 X 6"

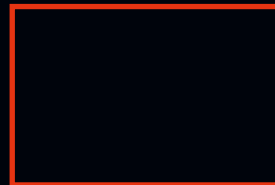

150 X 100 mm  
6 X 4"

## PRICE LIST

## PRICE LIST

### SQUARE & RECTANGULAR DOWNPIPE SYSTEM

#### DOWNPIPE LENGTHS

Pipe (mm)	75 x 50	75 x 75	100 x 75	100 x 100	150 x 100	150 x 150
3.0mtr	RW32/1	RW33/1	RW43/1	RW44/1	RW64/1	RW66/1
MILL	38.99	47.19	64.08	73.29	113.46	151.52
PPC	47.25	57.10	75.64	86.51	129.72	171.03
1.5mtr	RW32/4	RW33/4	RW43/4	RW44/4	RW64/4	RW66/4
MILL	24.88	29.94	39.38	44.81	69.73	90.37
PPC	29.01	34.90	45.16	51.42	77.86	100.13



#### ACCESS PIPES & PLATES

Pipe (mm)	75 x 50	75 x 75	100 x 75	100 x 100	150 x 100	150 x 150
Pipe With Plate	RW32/8	RW33/8	RW43/8	RW44/8	RW64/8	RW66/8
MILL	28.19	31.71	38.18	41.76	60.33	66.64
PPC	30.39	34.35	41.30	45.33	64.83	72.04
Plate Only	RW32/9	RW33/9	RW43/9	RW44/9	RW64/9	RW66/9
MILL	4.24	4.24	5.06	5.06	6.79	6.79
PPC	4.79	4.79	5.61	5.61	7.34	7.34

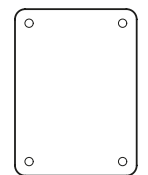
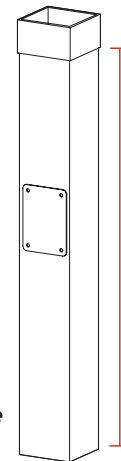

Access Plate

Access Pipe With Plate

#### SHOES

Pipe (mm)	75 x 50	75 x 75	100 x 75	100 x 100	150 x 100	150 x 150
Shoe	RW32/10	RW33/10	RW43/10	RW44/10	RW64/10	RW66/10
MILL	27.64	22.25	36.13	41.35	61.83	77.86
PPC	28.19	22.92	36.91	42.34	63.15	79.75

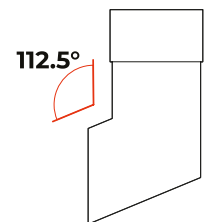
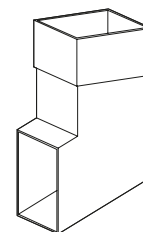

#### UNIVERSAL BRANCHES

Pipe (mm)	75 x 50	75 x 75	100 x 75	100 x 100	150 x 100	150 x 150
Branch	RW32/11	RW33/11	RW43/11	RW44/11	RW64/11	RW66/11
MILL	44.03	42.99	58.76	62.31	100.91	115.59
PPC	45.52	44.21	60.30	64.07	103.55	118.76

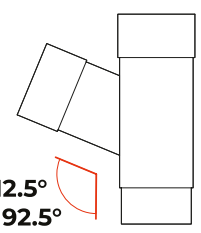
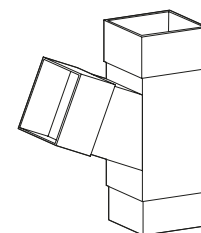

112.5° or 92.5°

112.5° branch shown

NOTE: NORMALLY USED WITH A BEND

## PRICE LIST

### SQUARE & RECTANGULAR DOWNPIPE SYSTEM

#### PIPE CLIPS & BRACKETS

Pipe (mm)	75 x 50	75 x 75	100 x 75	100 x 100	150 x 100	150 x 150
Standard Pipe Clip	RW32/16	RW33/16	RW43/16	RW44/16	RW64/16	RW66/16
MILL	3.79	3.79	3.87	3.87	6.66	6.66
PPC	4.34	4.34	4.42	4.42	7.21	7.21

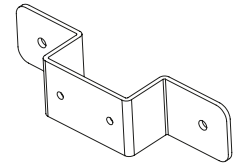

Standard Pipe Clip

Pipe (mm)	75 x 50	75 x 75	100 x 75	100 x 100	150 x 100	150 x 150
Tee Bkt 100mm	RW32/17	RW33/17	RW43/17	RW44/17	RW64/17	RW66/17
MILL	10.31	10.31	10.47	10.47	11.33	11.33
PPC	10.86	10.86	11.02	11.02	11.88	11.88
Tee Bkt 200mm	RW32/18	RW33/18	RW43/18	RW44/18	RW64/18	RW66/18
MILL	11.07	11.07	11.24	11.24	12.10	12.10
PPC	11.62	11.62	11.79	11.79	12.65	12.65
Tee Bkt 300mm	RW32/19	RW33/19	RW43/19	RW44/19	RW64/19	RW66/19
MILL	11.93	11.93	12.09	12.09	12.95	12.95
PPC	12.48	12.48	12.64	12.64	13.50	13.50

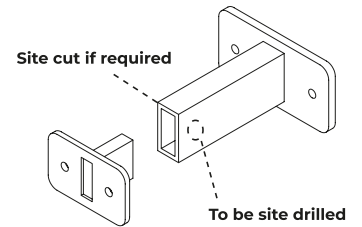

Tee Bracket

Pipe (mm)	75 x 50	75 x 75	100 x 75	100 x 100	150 x 100	150 x 150
Mullion Bkt 100mm	RW32/171	RW33/171	RW43/171	RW44/171	RW64/171	RW66/171
MILL	10.31	10.31	10.47	10.47	10.74	10.74
PPC	10.86	10.86	11.02	11.02	11.29	11.29
Mullion Bkt 200mm	RW32/181	RW33/181	RW43/181	RW44/181	RW64/181	RW66/181
MILL	11.07	11.07	11.24	11.24	12.10	12.10
PPC	11.62	11.62	11.79	11.79	12.65	12.65
Mullion Bkt 300mm	RW32/191	RW33/191	RW43/191	RW44/191	RW64/191	RW66/191
MILL	11.93	11.93	12.09	12.09	12.95	12.95
PPC	12.48	12.48	12.64	12.64	13.50	13.50

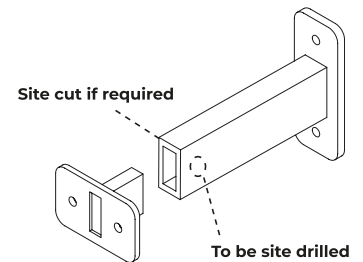

Mullion Bracket

Pipe (mm)	75 x 50	75 x 75	100 x 75	100 x 100	150 x 100	150 x 150
Flat Pipe Clip	RW32/14	RW33/14	RW43/14	RW44/14	RW64/14	RW66/14
MILL	3.40	3.40	3.47	3.47	3.85	3.85
PPC	3.95	3.95	4.02	4.02	4.40	4.40

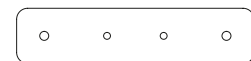

Flat Back Pipe Clip

Pipe (mm)	75 x 50	75 x 75	100 x 75	100 x 100	150 x 100	150 x 150
Concealed Pipe Clip	RW32/15	RW33/15	RW43/15	RW44/15	RW64/15	RW66/15
MILL	5.14	5.14	5.36	5.36	5.81	5.81
PPC	5.69	5.69	5.91	5.91	6.36	6.36

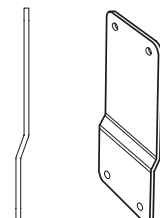

Concealed Pipe Clip

## PRICE LIST

### SQUARE & RECTANGULAR DOWNPIPE SYSTEM

#### CONNECTORS

Pipe (mm)	75 x 50	75 x 75	100 x 75	100 x 100	150 x 100	150 x 150
Connector	RW32/12	RW33/12	RW43/12	RW44/12	RW64/12	RW66/12
MILL	12.60	14.58	18.04	19.79	47.24	36.06
PPC	13.15	15.13	18.59	20.34	48.00	36.97

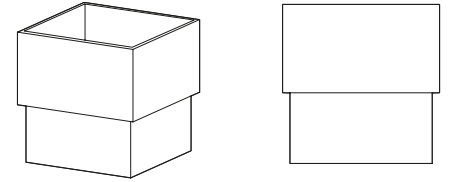

#### BENDS

Pipe (mm)	75 x 50	75 x 75	100 x 75	100 x 100	150 x 100	150 x 150
Bend	RW32/21	RW33/21	RW43/21	RW44/21	RW64/21	RW66/21
MILL	28.79	33.45	39.55	42.47	68.26	79.95
PPC	29.34	34.07	40.31	43.36	69.43	81.49

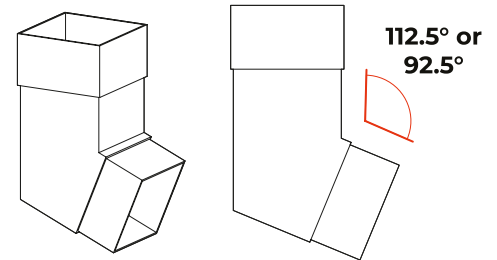

112.5° bend shown

NOTE: NORMALLY USED WITH A BRANCH

RECTANGULAR BENDS CAN ONLY BE USED AS A SIDE LEFT OR RIGHT NOT FORWARD OR REAR PROJECTING

#### PLINTH OFFSETS

Pipe (mm)	75 x 50	75 x 75	100 x 75	100 x 100	150 x 100	150 x 150
Offset Up To 150mm	RW32/23	RW33/23	RW43/23	RW44/23	RW64/23	RW66/23
MILL	65.92	73.92	80.04	88.14	122.46	143.46
PPC	67.24	75.63	81.81	90.51	125.38	146.90

NOTE: PLEASE STATE PROJECTION (P) SIZE

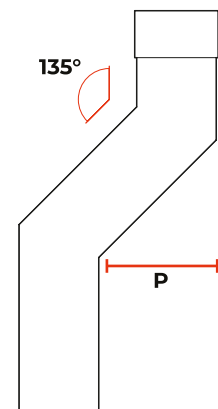

## PRICE LIST

### SQUARE & RECTANGULAR DOWNPIPE SYSTEM

#### SWAN NECKS

##### SWAN NECK 1 PIECE

Pipe (mm)	75 x 50	75 x 75	100 x 75	100 x 100	150 x 100	150 x 150
One Piece 300mm	RW32/25	RW33/25	RW43/25	RW44/25	RW64/25	RW66/25
MILL	66.42	74.01	80.69	90.45	119.31	176.69
PPC	67.94	75.57	83.00	93.21	122.70	180.92

NOTE: PLEASE STATE PROJECTION (P) SIZE

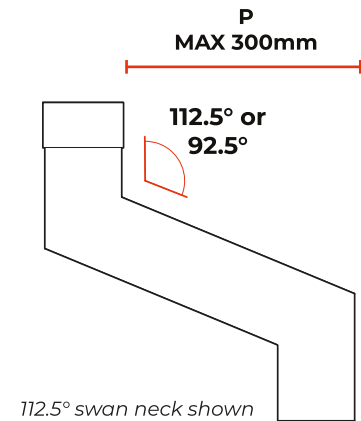

##### SWAN NECK 2 PIECE

Pipe (mm)	75 x 50	75 x 75	100 x 75	100 x 100	150 x 100	150 x 150
Two Piece 300mm	RW32/26	RW33/26	RW43/26	RW44/26	RW64/26	RW66/26
MILL	61.64	66.88	76.77	85.28	128.08	173.78
PPC	63.33	68.89	79.12	88.00	131.42	178.02
Two Piece 450mm	RW32/27	RW33/27	RW43/27	RW44/27	RW64/27	RW66/27
MILL	64.43	68.78	76.95	88.35	132.87	180.45
PPC	66.56	71.32	79.91	91.77	137.08	185.73
Two Piece 600mm	RW32/28	RW33/28	RW43/28	RW44/28	RW64/28	RW66/28
MILL	64.86	70.74	79.47	91.50	137.64	186.42
PPC	67.46	73.83	82.70	95.65	142.45	191.41
Two Piece 900mm	RW32/29	RW33/29	RW43/29	RW44/29	RW64/29	RW66/29
MILL	67.94	74.02	86.34	97.73	147.32	199.65
PPC	71.22	77.29	90.70	103.31	153.79	206.31
Two Piece 1200mm	RW32/30	RW33/30	RW43/30	RW44/30	RW64/30	RW66/30
MILL	71.21	77.90	90.37	104.13	157.29	214.76
PPC	75.36	82.09	95.95	111.19	165.47	225.41

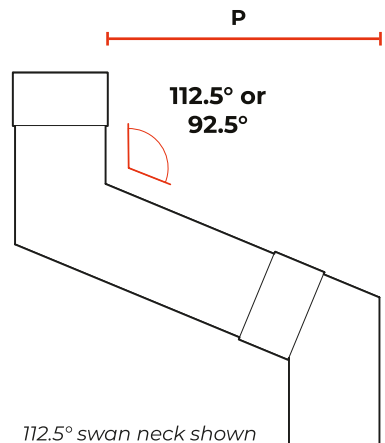

## PRICE LIST

### FIXINGS & SEALANTS

Code	Qty	Description	Price
GM1	25	Gutter Fixing 38 x 5.5 A2 Stainless Steel	4.56
GM2	100	Gutter Fixing 38 x 5.5 A2 Stainless Steel	13.86
GM3	200	Gutter Fixing 38 x 5.5 A2 Stainless Steel	26.90



GM1 - GM5

Code	Qty	Description	Price
GM201	25	4.8 x 14.7 All Aluminium sealed Rivet	3.38
GM202	100	4.8 x 14.7 All Aluminium sealed Rivet	12.46
GM203	200	4.8 x 14.7 All Aluminium sealed Rivet	23.38



GM201 - GM203

Code	Qty	Description	Price
GM610	25	6.3mm STRUCTURAL Aluminium Rivet	10.97
GM620	100	6.3mm STRUCTURAL Aluminium Rivet	39.11
GM630	200	6.3mm STRUCTURAL Aluminium Rivet	78.21



GM610 - GM620

Code	Qty	Description	Price
GM20	25	Downpipe Fixing 6 x 50 A2 Stainless Steel	9.81
GM21	100	Downpipe Fixing 6 x 50 A2 Stainless Steel	32.84



GM20 - GM21

Code	Qty	Description	Price
GM30	1	380ml Cartridge Silicone Sealant - Grey	11.00
GM32	1	1no 12mtr Reel Butyl Tape 12mm x 3mm	6.56
GM40	1	Touch Up Paint - Colour to match order	23.98
GM50	1	1no Drill Bit 4.8mm	2.06
GM51	1	1no Drill Bit 6.4mm	2.74



GM30



GM32



GM50 - GM60

Code	Qty	Description	Price
GM910	1	Standard Rainwater Rivet Gun	20.13
GM920	1	Professional Rivet Gun - Interchangeable collets for rain-water and structural rivets	115.19



GM910



GM920

## PRICE LIST

### CARRIAGE CHARGES

#### GUTTERS, DOWNPIPES & HOPPERS

TOTAL NET ORDER VALUE (EXCLUDING VAT)		PRICE
£0 - £99	BOXED UP TO 10KG	£15 Min Charge
£0 - £99	3M LENGTHS UP TO 10KGS	£30
£100 - £624		£40
£625 - £1249		£55
£1250 PLUS		FREE DELIVERY

Delivery Exclusions Apply:  
Please see the Charges  
section below

#### COPING, FASCIAS & SOFFITS

TOTAL NET ORDER VALUE (EXCLUDING VAT)	PRICE
£0 - £150	£40
£151 - £1249	£95
£1250 PLUS	FREE DELIVERY

Delivery Exclusions Apply:  
Please see the Charges  
section below

#### CHARGES

With a fleet of Guttercrest vehicles and outside couriers, we deliver all our aluminium products to your local builders merchant or direct to site.

##### SCOTTISH MAINLAND

Standard carriage charges apply on  
Postcode areas: DG, EH, G, KA, KY, TD

ALSO TO INCLUDE: DD1 - DD7, FK1 - FK7, FK9 - FK15,  
FK8 STERLING ONLY (Rest of FK8 will be price on application),  
KY1 - KY16, PA1 - PA19, PH1 - PH4, PH12 - PH14

All other Scottish Mainland, carriage price on application.

##### NON MAINLAND

For delivery to Northern Ireland, The Republic of Ireland  
and all offshore Islands, carriage Price on application.

##### EXPORT

Price on application.

Tel: +44 (0)1691 663300

Email: [info@guttercrest.co.uk](mailto:info@guttercrest.co.uk)

VAT will be charged at the appropriate rate.

