

# GUTTERCREST

## ALUMINIUM

### GEORGIAN SQUARE & RECTANGLE DOWNPIPES



75 X 75 mm  
3 X 3"



75 X 50 mm  
3 X 2"



100 X 100 mm  
4 X 4"



100 X 75 mm  
4 X 3"

## PRICE LIST

## PRICE LIST

### GEORGIAN SQUARE & RECTANGULAR DOWNPIPE SYSTEM

#### DOWNPIPE LENGTHS

Pipe (mm)	75 x 50	75 x 75	100 x 75	100 x 100
3.0mtr	RW32G/1	RW33G/1	RW43G/1	RW44G/1
MILL	50.84	59.70	76.42	85.44
PPC	59.10	69.61	87.98	98.66
1.8mtr	RW32G/3	RW33G/3	RW43G/3	RW44G/3
MILL	38.11	44.37	54.99	60.81
PPC	43.07	50.32	61.93	68.74

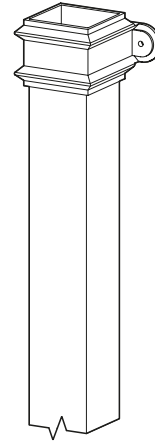

#### ACCESS PIPES & PLATES

Pipe (mm)	75 x 50	75 x 75	100 x 75	100 x 100
Pipe With Plate	RW32G/8	RW33G/8	RW43G/8	RW44G/8
MILL	38.77	42.71	48.22	51.71
PPC	41.03	45.49	51.46	55.41
Plate Only	RW32/9	RW33/9	RW43/9	RW44/9
MILL	4.27	4.27	5.10	5.10
PPC	4.82	4.82	5.65	5.65

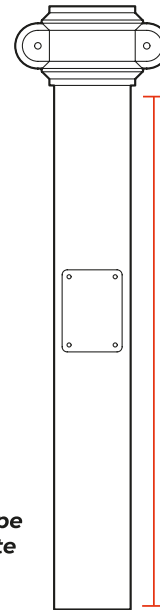

Approx  
700mm

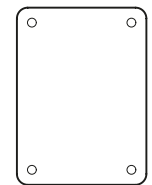

Access Plate

Access Pipe  
With Plate

#### SHOES

Pipe (mm)	75 x 50	75 x 75	100 x 75	100 x 100
Shoe	RW32G/10	RW33G/10	RW43G/10	RW44G/10
MILL	36.78	41.92	44.44	49.40
PPC	37.35	42.69	45.34	50.57

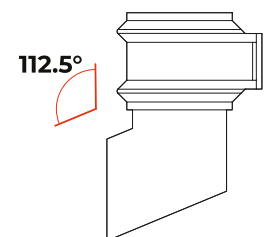
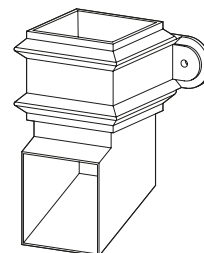

112.5°

## PRICE LIST

### GEORGIAN SQUARE & RECTANGULAR DOWNPIPE SYSTEM

#### UNIVERSAL BRANCHES

Pipe (mm)	75 x 50	75 x 75	100 x 75	100 x 100
Branch	RW32G/11	RW33G/11	RW43G/11	RW44G/11
MILL	66.16	74.74	79.64	88.80
PPC	66.91	75.64	80.80	90.13

NOTE: UNIVERSAL BRANCH FOR LEFT OR RIGHT, IF ONE PIECE IS REQUIRED PLEASE STATE INCLUDING LEFT OR RIGHT HAND

NOTE: NORMALLY USED WITH A BEND

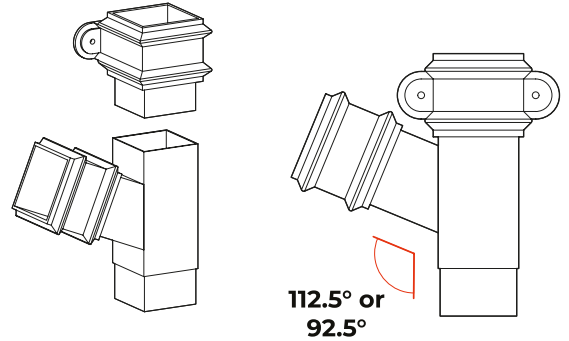

112.5° branch shown

#### CONNECTORS

Pipe (mm)	75 x 50	75 x 75	100 x 75	100 x 100
Connector No Ears	RW32G/12	RW33G/12	RW43G/12	RW44G/12
MILL	21.16	23.58	26.50	27.73
PPC	21.71	24.13	27.06	28.37
Connector Eared	RW32G/13	RW33G/13	RW43G/13	RW44G/13
MILL	22.72	26.14	25.84	29.57
PPC	23.27	26.69	26.40	30.21

NOTE: GROUND ADAPTORS AVAILABLE

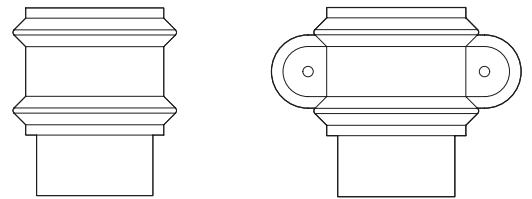

#### COLLAR BRACKETS

Pipe (mm)	75 x 50	75 x 75	100 x 75	100 x 100
Collar Bkt Eared	RW32G/15	RW33G/15	RW43G/15	RW44G/15
MILL	18.17	19.79	20.04	20.53
PPC	18.72	20.34	20.59	21.08

NOTE: THIS ITEM IS USED IN PLACE OF A BRACKET, FOR EXAMPLE AT THE BASE OF A DOWNPIPE IF NO SHOE IS REQUIRED

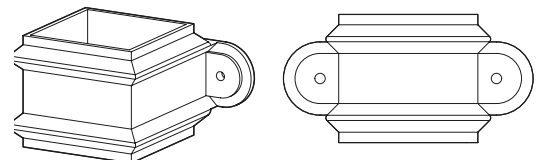

## PRICE LIST

### GEORGIAN SQUARE & RECTANGULAR DOWNPIPE SYSTEM

#### BENDS

Pipe (mm)	75 x 50	75 x 75	100 x 75	100 x 100
Side Bend No Ears	RW32G/21	RW33G/21	RW43G/21	RW44G/21
MILL	41.20	46.35	52.21	56.00
PPC	41.75	47.00	52.97	56.95
Side Bend Eared	RW32G/22	RW33G/22	RW43G/22	RW44G/22
MILL	42.75	48.91	51.55	57.83
PPC	43.30	49.56	52.31	58.78

NOTE: UNIVERSAL BENDS FOR LEFT OR RIGHT, IF ONE PIECE IS REQUIRED PLEASE STATE INCLUDING LEFT OR RIGHT HAND

NORMALLY USED WITH A BRANCH

RECTANGULAR BENDS CAN ONLY BE USED AS A SIDE LEFT OR RIGHT NOT FORWARD OR REAR PROJECTING

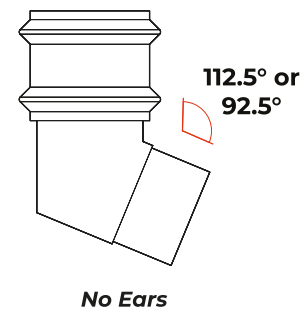
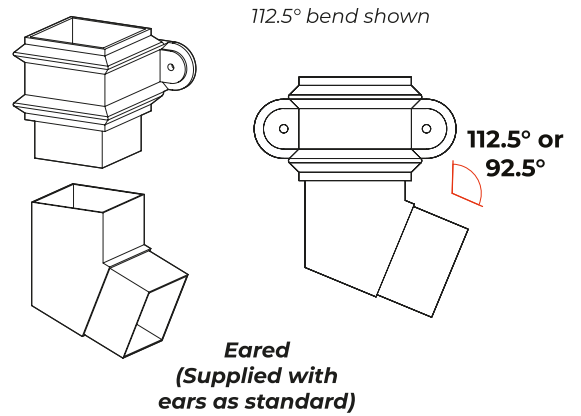

#### PLINTH OFFSETS

Pipe (mm)	75 x 50	75 x 75	100 x 75	100 x 100
Offset Up To 150mm	RW32G/23	RW33G/23	RW43G/23	RW44G/23
MILL	75.29	83.05	88.47	95.55
PPC	76.58	84.60	90.32	97.70

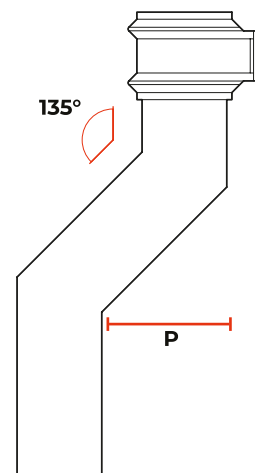

## PRICE LIST

### GEORGIAN SQUARE & RECTANGULAR DOWNPIPE SYSTEM

#### SWAN NECKS

##### SWAN NECK 1 PIECE

Pipe (mm)	75 x 50	75 x 75	100 x 75	100 x 100
One Piece 300mm	RW32G/25	RW33G/25	RW43G/25	RW44G/25
MILL	76.68	85.17	91.87	99.03
PPC	78.40	87.15	94.18	101.77

NOTE: PLEASE STATE PROJECTION (P) SIZE

##### SWAN NECK 2 PIECE

Pipe (mm)	75 x 50	75 x 75	100 x 75	100 x 100
Two Piece 300mm	RW32G/26	RW33G/26	RW43G/26	RW44G/26
MILL	55.86	65.75	76.13	76.37
PPC	57.73	67.94	78.69	79.44
Two Piece 450mm	RW32G/27	RW33G/27	RW43G/27	RW44G/27
MILL	57.64	67.89	77.32	79.20
PPC	59.95	70.61	80.50	82.97
Two Piece 600mm	RW32G/28	RW33G/28	RW43G/28	RW44G/28
MILL	59.24	69.81	79.71	82.31
PPC	62.01	73.08	83.52	86.81
Two Piece 900mm	RW32G/29	RW33G/29	RW43G/29	RW44G/29
MILL	64.27	74.02	87.77	89.72
PPC	67.93	78.36	92.84	95.65
Two Piece 1200mm	RW32G/30	RW33G/30	RW43G/30	RW44G/30
MILL	66.96	79.11	91.44	97.98
PPC	71.53	84.54	97.78	105.36

NOTE: PLEASE STATE PROJECTION (P) SIZE

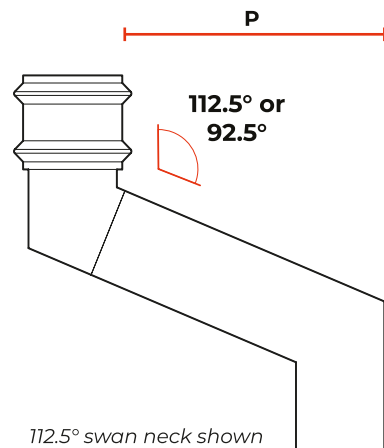
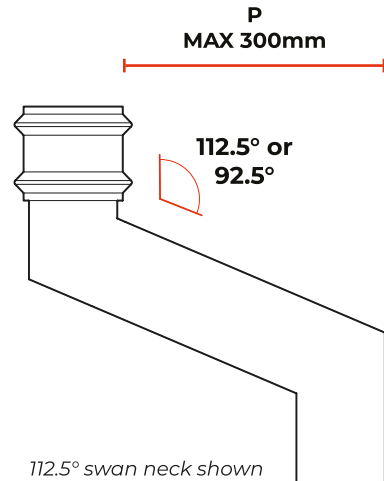

## PRICE LIST

### FIXINGS & SEALANTS

Code	Qty	Description	Price
GM1	25	Gutter Fixing 38 x 5.5 A2 Stainless Steel	4.56
GM2	100	Gutter Fixing 38 x 5.5 A2 Stainless Steel	13.86
GM3	200	Gutter Fixing 38 x 5.5 A2 Stainless Steel	26.90



GM1 - GM5

Code	Qty	Description	Price
GM201	25	4.8 x 14.7 All Aluminium sealed Rivet	3.38
GM202	100	4.8 x 14.7 All Aluminium sealed Rivet	12.46
GM203	200	4.8 x 14.7 All Aluminium sealed Rivet	23.38



GM201 - GM203

Code	Qty	Description	Price
GM610	25	6.3mm STRUCTURAL Aluminium Rivet	10.97
GM620	100	6.3mm STRUCTURAL Aluminium Rivet	39.11
GM630	200	6.3mm STRUCTURAL Aluminium Rivet	78.21



GM610 - GM620

Code	Qty	Description	Price
GM20	25	Downpipe Fixing 6 x 50 A2 Stainless Steel	9.81
GM21	100	Downpipe Fixing 6 x 50 A2 Stainless Steel	32.84



GM20 - GM21

Code	Qty	Description	Price
GM30	1	380ml Cartridge Silicone Sealant - Grey	11.00
GM32	1	1no 12mtr Reel Butyl Tape 12mm x 3mm	6.56
GM40	1	Touch Up Paint - Colour to match order	23.98
GM50	1	1no Drill Bit 4.8mm	2.06
GM51	1	1no Drill Bit 6.4mm	2.74



GM30



GM32



GM50 - GM60

Code	Qty	Description	Price
GM910	1	Standard Rainwater Rivet Gun	20.13
GM920	1	Professional Rivet Gun - Interchangeable collets for rain-water and structural rivets	115.19



GM910



GM920

## PRICE LIST

### CARRIAGE CHARGES

#### GUTTERS, DOWNPIPES & HOPPERS

TOTAL NET ORDER VALUE (EXCLUDING VAT)		PRICE
£0 - £99	BOXED UP TO 10KG	£15 Min Charge
£0 - £99	3M LENGTHS UP TO 10KGS	£30
£100 - £624		£40
£625 - £1249		£55
£1250 PLUS		FREE DELIVERY

Delivery Exclusions Apply:  
Please see the Charges  
section below

#### COPING, FASCIAS & SOFFITS

TOTAL NET ORDER VALUE (EXCLUDING VAT)	PRICE
£0 - £150	£40
£151 - £1249	£95
£1250 PLUS	FREE DELIVERY

Delivery Exclusions Apply:  
Please see the Charges  
section below

#### CHARGES

With a fleet of Guttercrest vehicles and outside couriers, we deliver all our aluminium products to your local builders merchant or direct to site.

##### SCOTTISH MAINLAND

Standard carriage charges apply on  
Postcode areas: DG, EH, G, KA, KY, TD

ALSO TO INCLUDE: DD1 - DD7, FK1 - FK7, FK9 - FK15,  
FK8 STERLING ONLY (Rest of FK8 will be price on application),  
KY1 - KY16, PA1 - PA19, PH1 - PH4, PH12 - PH14

All other Scottish Mainland, carriage price on application.

##### NON MAINLAND

For delivery to Northern Ireland, The Republic of Ireland  
and all offshore Islands, carriage Price on application.

##### EXPORT

Price on application.

Tel: +44 (0)1691 663300

Email: [info@guttercrest.co.uk](mailto:info@guttercrest.co.uk)

VAT will be charged at the appropriate rate.

